



415 Osage Avenue, Kansas City, KS 66105

Phone: 913-281-0722

Fax: 931-281-3315

www.t-kennel.com

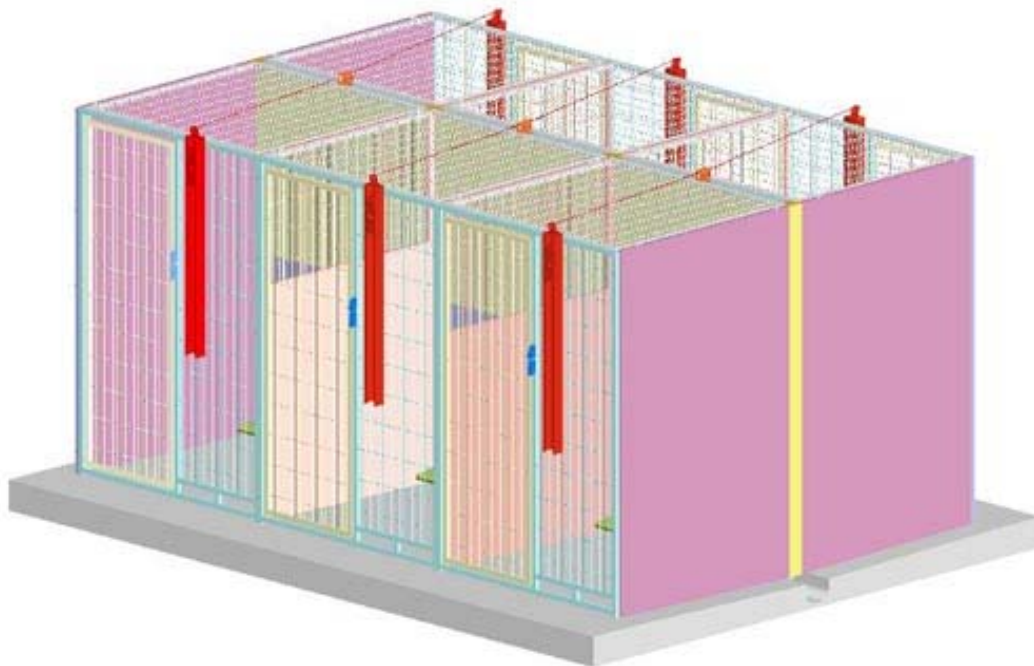

Double Kennel Installation on Concrete Floor

PN:006.5100.07

Updated: 8-1-2014

TABLE OF CONTENTS

SECTION	PAGE
INTRODUCTION	3
A. Tools Required	4
B. Kennel Assembly Hardware	5-6
C. King Post and Side Panel Assembly	7
D. Attach Gate Panel to King Post	8
E. Attach Second Side Panel to Gate Panel	9
F. Complete the First Section of kennels	9
G. Attach Brackets to the Side Panels and Vertical Slide Panels	10-11
H. Decorative Strip Installation	12
I. Install Counterweight System for the Transfer Door	13-16
J. Install Full T Cover	17
K. Sealing Kennel Assembly	18
L. Install Striker Bar and Latch Assembly	19
M. Installation Options	20
1. Top Wire Panel	20
2. Side Transfer Door Assembly	21-22
3. Feed Tray Cam Lock Installation	23

INTRODUCTION

Thank you for placing your trust in T Kennel Systems. T Kennel values you as a customer and will do everything we can to provide quality products and service, to assure your experience with T Kennel is a pleasant one.

The animal kennel system you have purchased has been precision made and shipped according to your instructions. Once assembled, your system will look custom built and especially made for your animal holding area.

For your personal safety, the safety of your workers, the public safety, and to maintain your kennel system it is very important to read and follow all instructions.

KENNEL INSTALLATION MANUALS ARE AVAILABLE FOR:

Single Kennel Installation on Raised Floor

Double Kennel Installation on Raised Floor

Single Kennel Installation on Concrete Floor

Double Kennel Installation on Concrete Floor

SAFETY FIRST:

▲ | CAUTION Kennels are heavy and precautions must be taken to protect from personal injury. Get help when lifting heavy parts.

▲ | CAUTION Edges of steel and stainless steel kennels and parts may be sharp. We recommend that you always wear protective gloves during unloading, inspection and assembly.

▲ | WARNING T Kennel products are designed for animal use only. Never allow a person in or on your Kennel Assembly.

A. Tools Required (Not Included)

This list of tools is the minimum required to install/assemble your Kennels. Depending on your facility and kennel configuration, you may need additional tools and/or specialty tools.

 <p>RATCHET/SOCKET WRENCH WRENCH 5/16" AND 7/16"</p>	 <p>CAULKING GUN</p>
 <p>7/16 COMBINATION WRENCH</p>	 <p>SAUSAGE GUN Only required if Sealant Sausages are provided</p>
 <p>5/16" HEX HEAD DRIVER</p>	 <p>WIRE CRIMPING TOOL 3/32 FERRULE Only required for Transfer Door application</p>
 <p>SCREW GUN</p>	 <p>WIRE CUTTER Only required for Transfer Door application</p>

Other Tools: Tape Measure, Straight-Line (Laser or String), Pry-Bar, Screw Driver, Hammer, Chalk Line, Saw Zall with Bi-Metal Blade, Hammer Drill with concrete Bit, Tin Snip and Hacksaw.

B. Kennel Assembly Hardware

The hardware pictured below is for the assembly of T-Kennel's standard Single Kennel System. Your hardware may vary depending upon your kennel configuration, building design, etc. Please feel free to call our Sales Department or Tech Services Department if you have any questions.

 041.0069.02 STRIKER BAR	 731.0000.00 LATCH ASSEMBLY-LH	 041.0087.00 BRACKET-LH	 041.0087.01 BRACKET-RH
 061.1010.00 #12X1 TEK SCREW	 061.1020.01 #12X2 TEK SCREW	 062.2515.00 1/4-20X1.5 CAP SCREW	 064.2500.22 1/4-20 NYLOCK NUT
 300.1333.00 X-BRACKET	 300.1334.00 T-BRACKET	 731.0000.01 LATCH ASSEMBLY-LH FOR GLASS GATE PANEL	 060.5000.00 SCREW 1/2 FL WASHER
 043.0004.01 SLEEVE (FERRULE)	 PULLEY BRACKET ASSEMBLY	 PULLEY BRACKET ASSEMBLY FOR THE REVERSE GATE PANEL	 COUNTERWEIGHT
 058.1005.00 KNOB 1/4-20X3/4 STUD	 178.0008.00 ADHESIVE E6000, TUBE CAULKING GUN REQUIRED	 SIKAFLEX SEALANT TUBE CAULKING GUN REQUIRED	 SIKAFLEX SEALANT SAUSAGE SAUSAGE GUN REQUIRED
 COUNTERWEIGHT GUIDE			
 KING POST			
 PVC STRIP 3" WIDE X 96" LONG X 3/32" THICK		 178.0009.00 TAPE, 2 FACE	

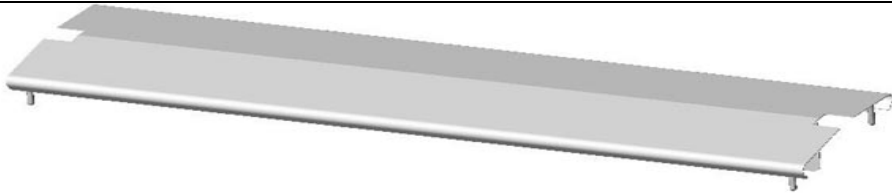

FULL T-COVER



SIKAFLEX PRIMER
016.0001.00

C. King Post and Side Panel Assembly

(Note: The Kennel System is designed to assemble from left to right.)



King Post

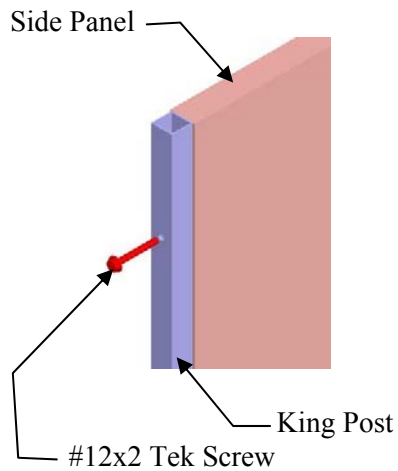

Figure 1

1. Attach a King Post to the first Side Panel on the far left using 2" Self-Drilling Tek Screws through the pre-drilled holes (**Figure 1**). The King Post should always mount to the short front end of the Side Panel.

Remove Door from each Gate Panel

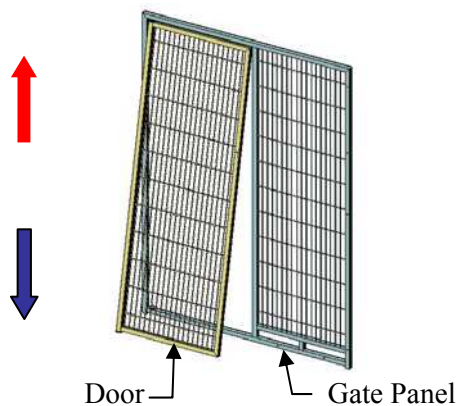

Figure 2

2. Locate the Gate Panels and remove the Door from each Gate Panel. Slightly open and lift up on the door. Once the Door clears the hinge pin at the bottom, pull the bottom of the Door toward you (**Figure 2**). Pull the top of the Door down until the top of the Door clears the top hinge pin.

Mark all of the Doors so that they match with the original Gate Panels. Put the Doors aside until all the Gate Panels are ready to attach.

D. Attach Gate Panel to the King Post

1. Set the first Side Panel (with King Post attached) on the left side of the concrete floor. Be sure the bottom of the panel slopes from the front to back of the Kennel. Have a helper hold it in place (**Figure 3**).
2. Attach the Gate Panel to the King Post using 2" Self-Drilling Tek Screws through the pre-drilled holes. Make sure that Gate Panel and King Post are flush up against each other (**Figure 4**).

Note: For kennels with the optional Stainless Steel Gates, you must pre-drill a pilot hole for the 2" self-drilling Tek Screws. Using the pre-drilled holes as a guide, drill 3/16" hole into the King Post or Gate Panel you are installing. We strongly suggest using a Cobalt drill-bit for this step.

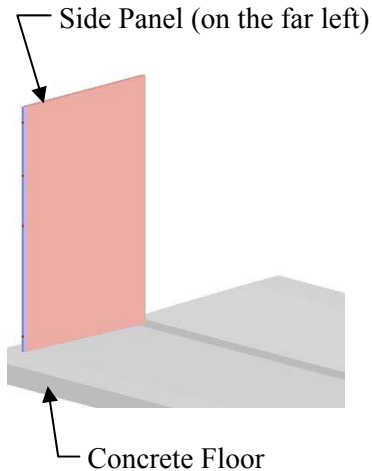

Figure 3

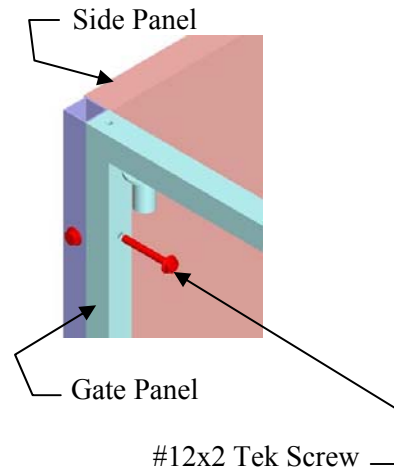

Figure 4

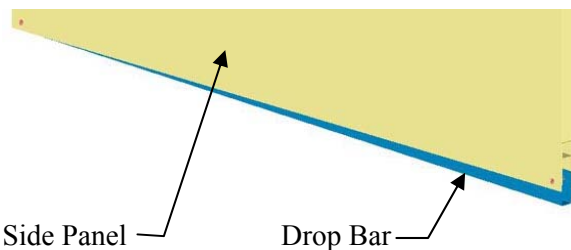

Figure 5

Note: On standard Side Panels, the slope is 1/4" per foot. Refer to your layout to confirm floor slope.

To match the bottom of the Side Panel with the slope of the concrete floor, adjust the Drop Bar, (located inside the u-channel at the bottom of the side panel), by pulling it downwards. (**Figure 5**). Make sure the Side Panel is level at the Top.

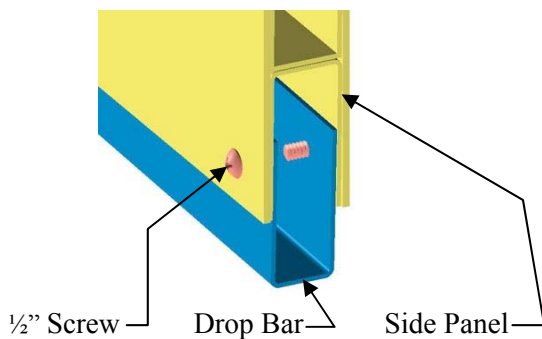

Figure 6

After making the final adjustment of the Drop Bar, secure it in place with 1/2" self-drilling screws on both sides of Side Panel at both ends as shown in (**Figure 6**).

Field Note: If the floor is not uniform, the Drop Bar can be cut and adjusted to adapt to most common floor irregularities.

E. Attach Second Side Panel to the Gate Panel

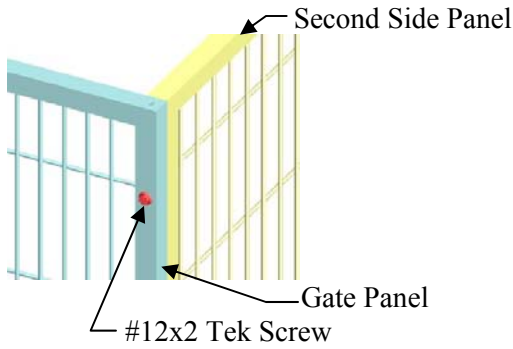

Figure 7

3. Attach the Second Side Panel to the Gate Panel using 2" Self-Drilling Tek Screws through the pre-drilled holes (**Figure 7**).

Note:

From the Second Kennel on, the Gate Panels will attach to the preceding Kennels' Gate.

F. Complete the First Section of Kennels

4. Locate the second Gate Panel and attach it to the first Gate Panel using 2" Self-Drilling Tek Screws through the pre-drilled holes as shown in (**Figure 8**). Assemble the rest of the Gate and Side Panels, for the first section as shown in (**Figure 8A**).

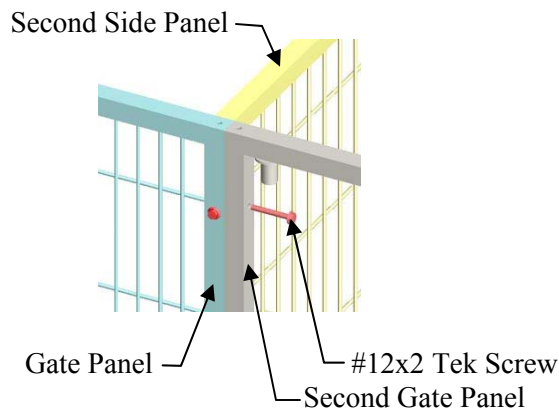

Figure 8

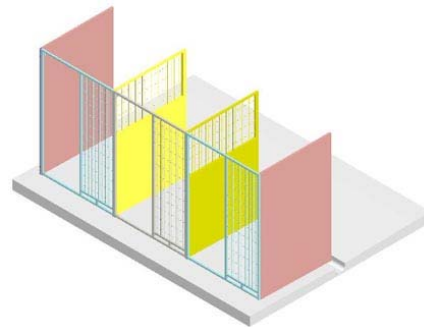

Figure 8A

5. Locate the Vertical Slide Panels and place them inside the kennels you have already half way assembled as shown in (**Figure 9**).

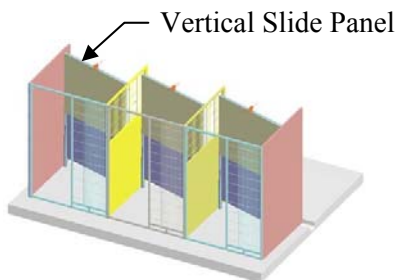

Figure 9

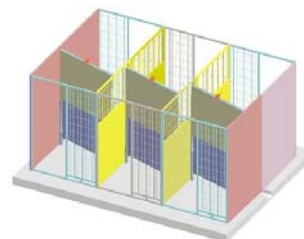

Figure 10

6. Begin assembling the second section of kennels, starting from the left side with a King Post and a Side Panel as shown in the (**Figure 10**), just like the first row, now follow (**Figures 3 thru 8**) again to complete the second section.

G. Attach Brackets to the Side Panels and Vertical Slide Panels

If your shipment includes T-Brackets and X-Brackets, see installation option on the page 12 before installing the Panels.

Note: Make sure the Vertical Slide Panels are centrally located on the joint between Side Panels before attaching the brackets.

1. Locate LH & RH Brackets that have three drilled holes. Attach the brackets to both sides of the Vertical Slide Panel using 1" self drilling Tek screws. Make sure to flush the Brackets with the top face of the Vertical Slide Panel (**Figure 11**).

2. After attaching the Brackets to the Vertical Slide Panel and you will notice it is taller than the Side Panels (**Figure 11**). Position the Vertical Slide Panel in the middle of the kennels by bringing its legs inside the trench drain (**Figure 11A**) and mount to the Side Panels using 1" self-drilling Tek screws. Be sure to flush the top of the Side Panels with the top of Vertical Slide Panel before attaching (**Figure 12**). Have another helper hold in place while you attach. Follow the same instructions to attach the brackets to the Side Panels on the other side of Kennels (**Figure 12A**).

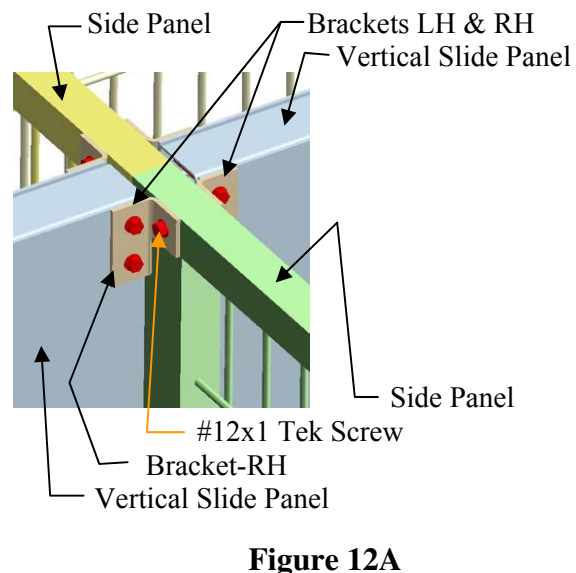
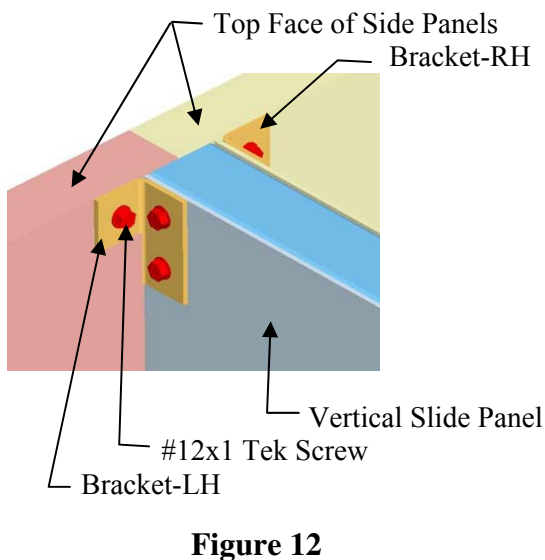
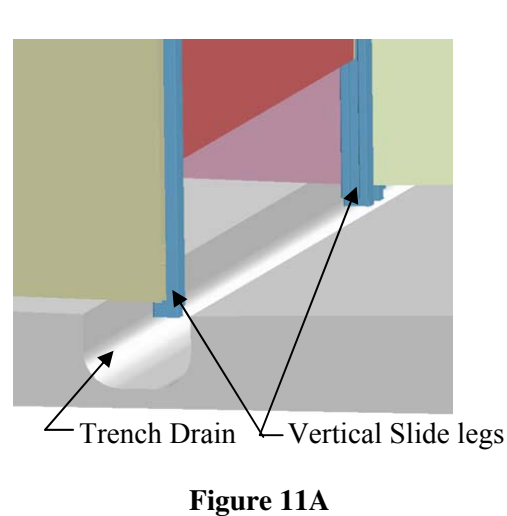
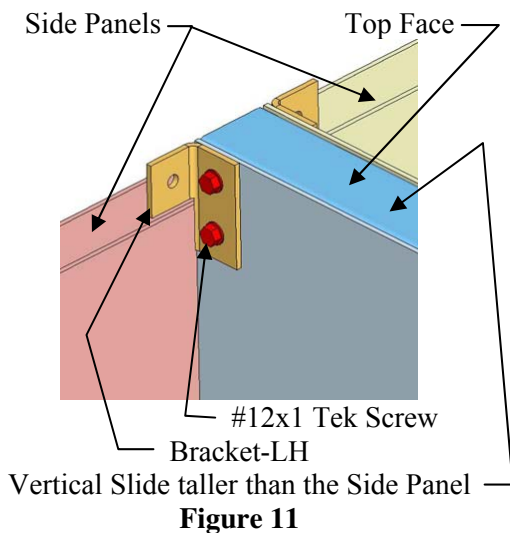

Note: On Double Kennels that have different depths the Vertical Slide will not be exactly flush with both sides of the side panels because each side of the kennel's slope will be different. (For example if a double kennel depth is 4' deep on one side and 6' deep on the other the over all drop of the 4' side will be different than the 6' side.)

3. Locate the LH and RH Brackets (**Figure 13 & 14**) that have three drilled holes. Use 1" Tek Screws to attach the Brackets to the Side Panels and both sides (legs) of the Vertical Slide Panel. The Brackets should be flush with the bottom of the Side Panels as shown in (**Figure 13 & 14**).

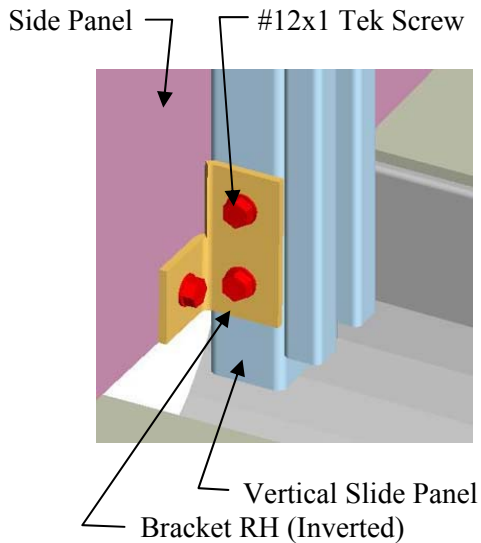

**Bottom Lower LH Corner
Figure 13**

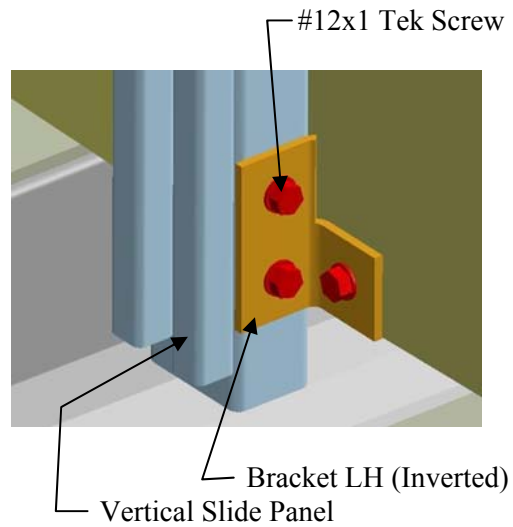

**Bottom Lower RH Corner
Figure 14**

Installation Option (Side Panels and Vertical Slide Panels)

If your shipment came with X brackets and T brackets as shown in (**Figure 15 & 16**). Please follow the directions below.

Note: Make sure the Vertical Slide Panels are centrally located on the joint between Side Panels before attaching the brackets.

1. For Side Panels and Verticals Slide Panels at the end of each row, attach a T-Bracket on the top of both joining Side Panels and Vertical Slide Panel using 1" self-drilling Tek Screws as shown in **(Figure 15)**. Follow the same instructions to attach Bracket on the other end of the kennels.

2. For all other Side Panels and Vertical Slide Panels in the row, attach an X-Bracket by placing it on the top of both joining Side Panels and both Vertical Slide Panels using 1" self-drilling Tek Screws as shown in **(Figure 16)**.

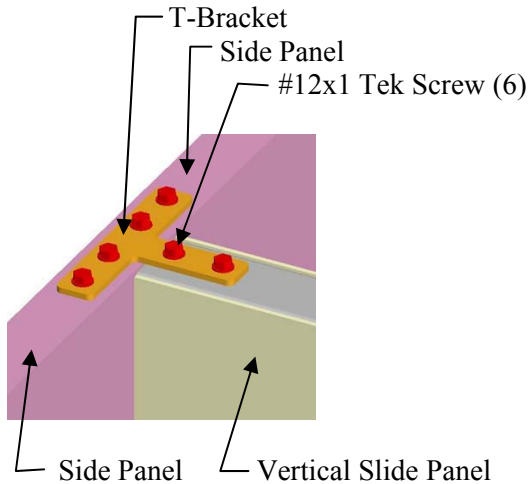

Figure 15 (On the Top)

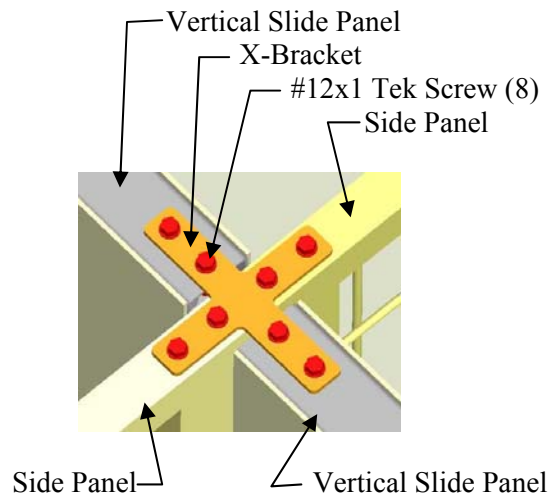

Figure 16 (On the Top)

H. PVC Decorative Strip Installation

3" PVC Strips have been provided to cover the seam where the two side panels butt up against each other at the outside ends of the double kennels. To install the optional 3" PVC Strip, measure the length needed to cover the seam and cut to length. Apply a row of 2-sided adhesive tape down each side of the PVC Strip **(Figure 17)**. Peel back approximately 1" **(Figure 18)** of the protective backing on the tape rows and place the PVC Strip evenly over the seam to be covered. Working from top to bottom press the PVC Strip down firmly, and slowly pull the protective cover off the adhesive tape while applying pressure to the strip **(Figure 19)**.



PVC Strip shown with Tape
Figure 17



PVC strip shown with tape is peeled.

Figure 18

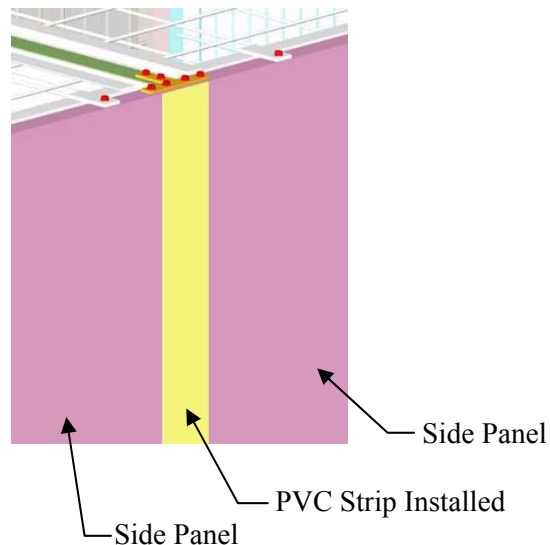

Figure 19

I. Install Counterweight System for the Transfer Door

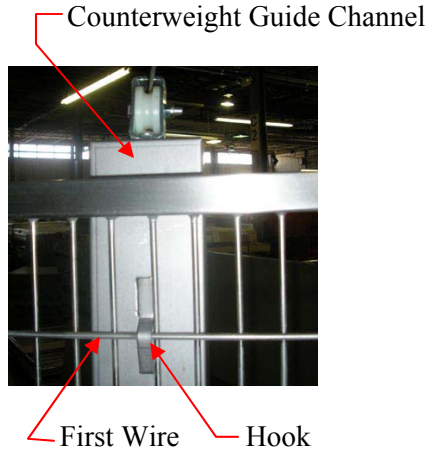

Figure 20

Insert Counterweight Guide Channel into the first and fourth wire to the right of the Gate Panel opening using the hooks welded to the back of the Counterweight Guide Channel as shown in (Figure 20 & 21).



Figure 21

Note: To install the counterweights, check to make sure the sliding door in the Vertical Slide Panel is secure in the open (up) position, which is held in position with a setscrew, installed by the factory. This setscrew is located in the door channel. Do not remove it until you install both counterweights.

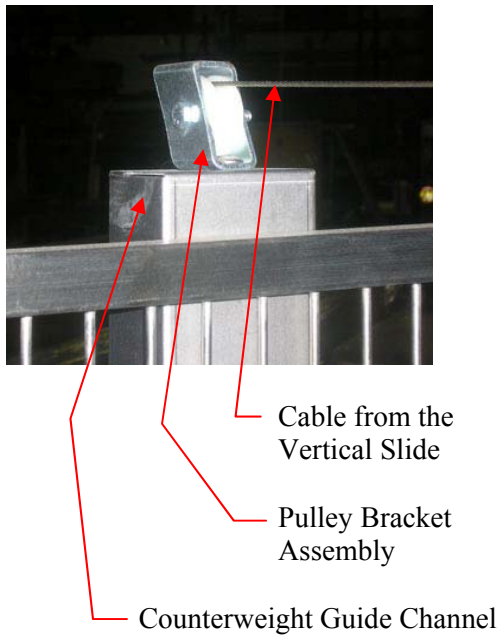

Figure 22

After installing the counterweight guide channel, route the cable from the Vertical Slide Panel over the nylon pulley wheel (which is the part of the pulley bracket assembly that is mounted on the top of the counterweight guide) down through the hole in the top of the counterweight guide channel (Figure 22 & 23).

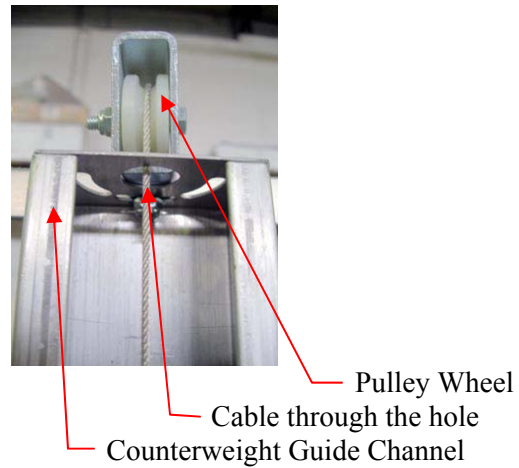

Figure 23

Note: Two persons will be required to complete the following steps.

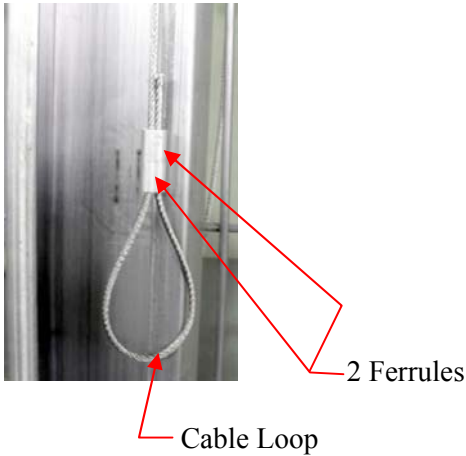

Figure 24

With the cable properly routed into the counterweight guide channel, have person #1 slide two (2) ferrules onto the cable then make a loop with the cable, and route the cable back through the two (2) ferrules (**Figure 24**).

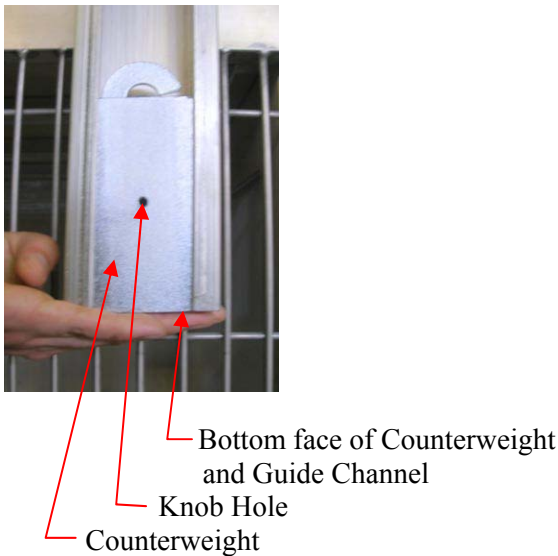

Figure 25

Have person #2 locate the counterweight to be installed and place it into the bottom of the counterweight guide channel. Make sure the threaded knob hole is facing outward. Slide the weight up until the bottom of the weight is even with the bottom of the counterweight guide channel (**Figure 25**).

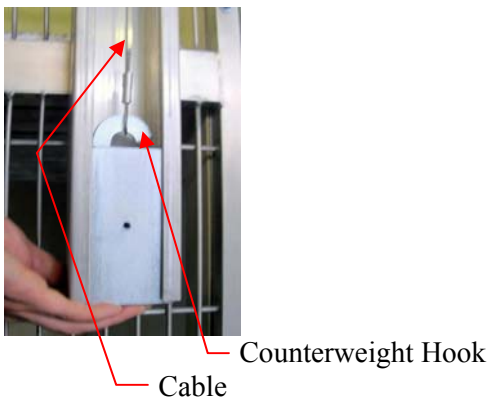
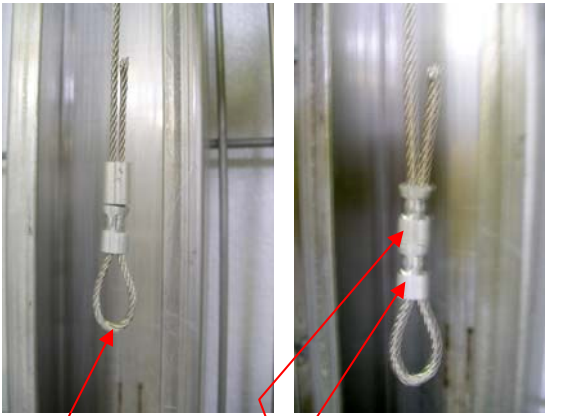

Figure 26

Place the cable loop around the counterweight hook at the top of the counterweight. Pull the cable tight so there is no slack from the Vertical Slide Panel to the counterweight. Leave enough slack in the loop to allow the counterweight to be removed (**Figure 26**).



Cable Loop 2 Ferrules (Crimped)

Figure 27

Slide the cable loop off of the counterweight hook and have person #2 set the counterweight on the floor. With person #1 holding the cable loop and ferrules secure, person #2 can now crimp both Ferrules tightly with crimping tool. (**Figure 27**).

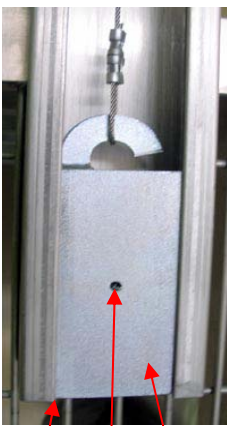

Counterweight Knob Hole Bottom face of Counterweight Guide Channel

Figure 28

Install counterweight back into the counterweight guide channel with the threaded hole facing outward (**Figure 28**). Slide cable loop over counterweight hook and allow counterweight to hang freely. Trim off any excess cable (**Figure 29**).

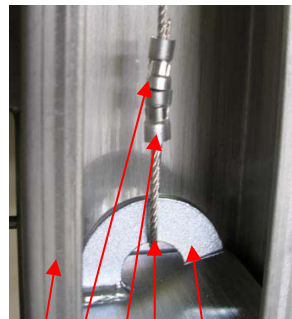

Counterweight Hook Cable Two Ferrules (Crimped) Counterweight Guide Channel

Figure 29

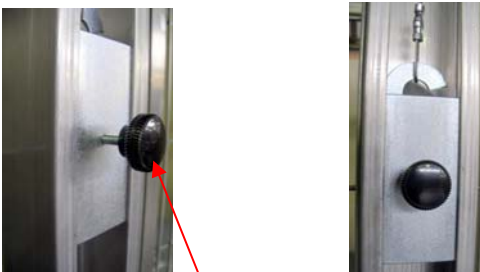

Knob

Figure 30

Install the Knob into the threaded hole in the Counterweight (**Figure 30**).

After all the counterweights are installed, remove the setscrew from the track of the Vertical Slide Panel(s). This will release the door and all the Counterweights will control the movements of the door.

Standard Pulley System

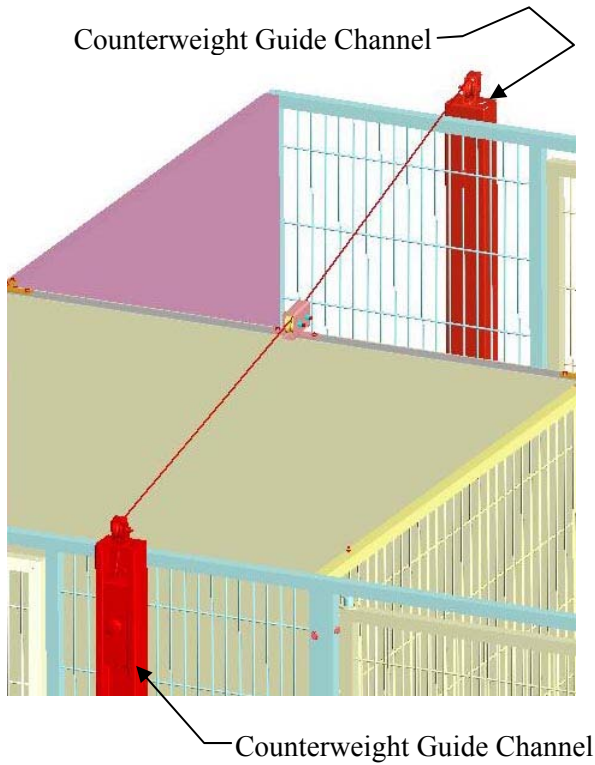

Figure A

In the Standard Pulley System, the cable will be in line between both Counterweight Guide Channels as shown in (Figure A & B).

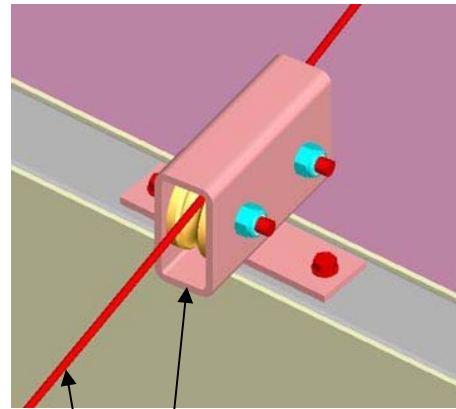

Figure B

Option: Reverse Pulley System (For the Reverse Gate Panel)

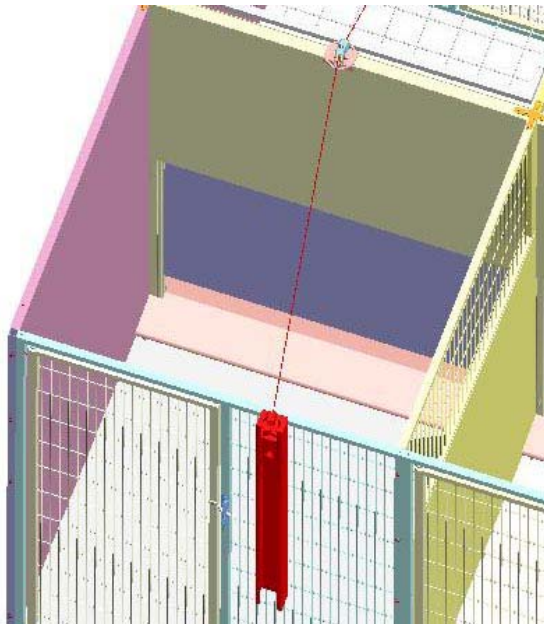

Figure C

In the Reverse Pulley System, the cable will be set at an angle between both Counterweight Guide Channels because of Reverse Gate Panel as shown in (Figure C & D).

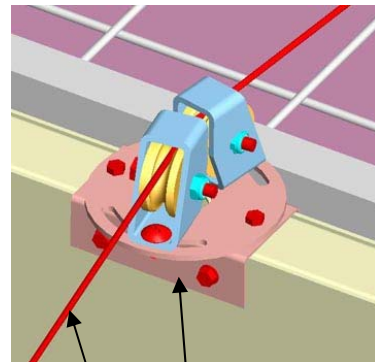
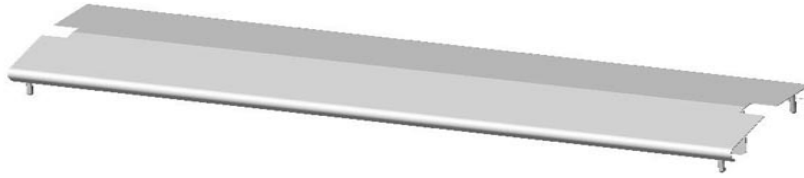

Figure D

J. Install Full T Cover



Full T Cover

Tilt the Full T cover to install between two legs of Vertical Slide Panel, first placing on one leg in the cutout of Full T Cover as shown in **(Figure 31)**. The legs of the Full T Cover will touch the Floor and it will fully cover the trench drain **(Figure 32 & 33)**.

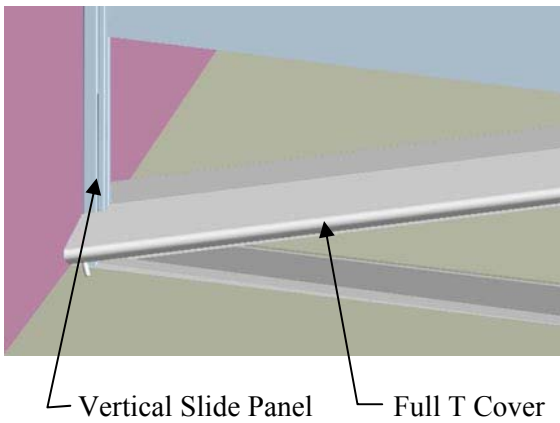

Figure 31

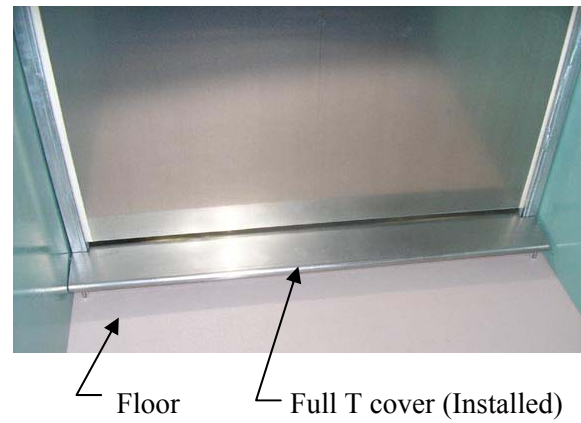

Figure 32

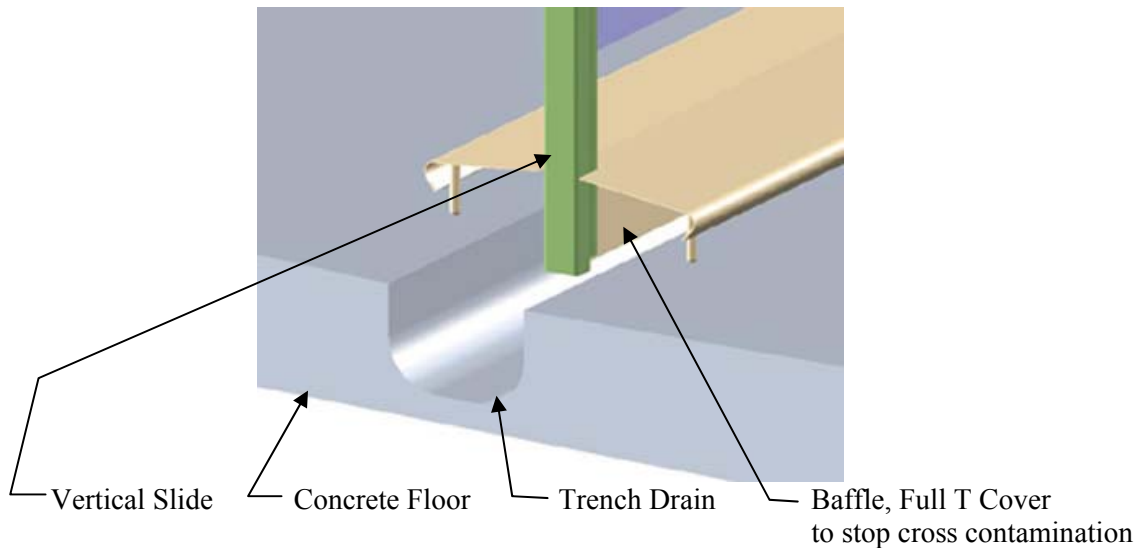

Figure 33

K. Sealing Kennel Assembly

Plan in advance to seal the kennel assembly. The goal is to start in the back of the kennel and work your way out. Having to walk into a freshly sealed kennel may compromise the sealant and possibly cause leaking.

1. Use a primer or Isopropyl Alcohol (Make sure to read health hazard information) to clean all the corners, cracks, edges, and areas that need to be sealed. This should remove any dust or oil that would inhibit good adhesion (**Figure 34**).
2. Cut the Sealant (page 13) tube (**Figure 35**) end off at a 60° angle. The hole should be about the diameter of a ballpoint pen. Use a coat hanger or longer pin to poke a hole in the Sealant tube to start the flow (**Figure 36**).



Figure 34



Figure 35



Figure 36

Sealing Tip: Running a strip of masking tape (**Figure 37**) approximately ¼” from either side of the seam to be sealed will help produce a professional looking caulking job.



Figure 37



Figure 38



Figure 39



Figure 40



Figure 41

3. Begin sealing at the back of the kennel. Seal the corners where the Side Panels meet the Vertical Slide Panel, working top to bottom. Smooth the sealant with the tip of your gloved finger so that there are no gaps or pinholes in the sealant. It may help to dip your gloved finger into a bowl of dish detergent to prevent sticking. After applying and smoothing the sealant with your finger, peel off the masking tape using caution not to smear the fresh sealant.

Seal the Side Panels to the floor working back to front. Smooth the sealant with the tip of your gloved finger so that there are no gaps or pinholes in the sealant.

4. Refer to the sealant manufacturer’s directions for drying times. We strongly suggest waiting at least 72 hours for the sealant to cure completely before applying any water or using the kennels.

L. Install Striker Bar and Latch Assembly

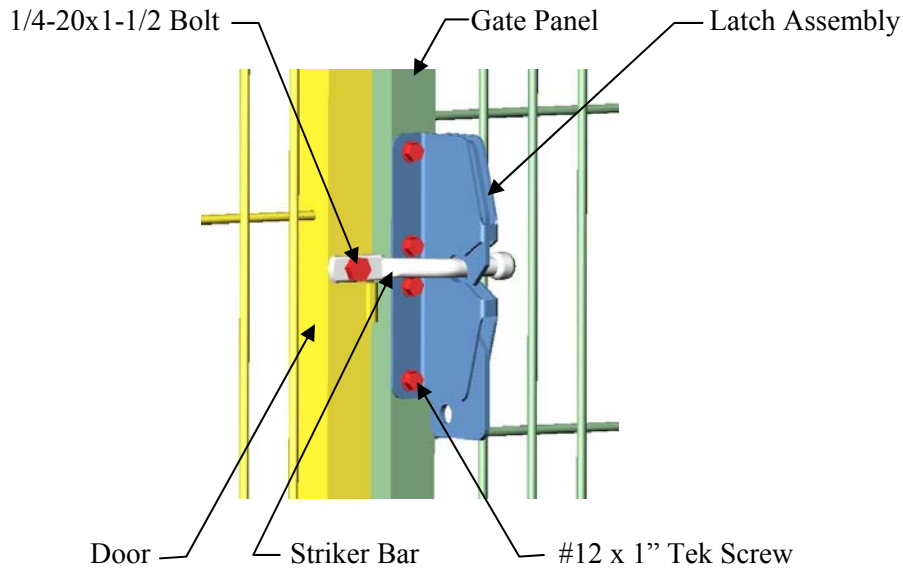

Figure 42

1. Install the Striker Bar to the pre-drilled Door using a 1/4"-20 x 1-1/2 Hex Bolt and 1/4"-20 Nylox Nut (**Figure 42**). Position the Striker bar into a horizontal position.

Note:

To install the Latch Assembly to the Stainless Steel Gate Panel, you must pre-drill the holes using a 3/16 cobalt drill bit through only one wall of tube for the 1" Tek Screws by matching with the pre-drilled holes in the Latch Assembly.

2. Hold the Latch Assembly in place against the Gate Panel and close the Door. Make sure to center the Striker Bar within the latch pocket and latch looks straight. Using (4) 1" Tek Screws, mount the Latch Assembly to the Gate Panel (**Figure 42 & 42A**).

Latch Assembly for optional Glass Gate Panel Assembly

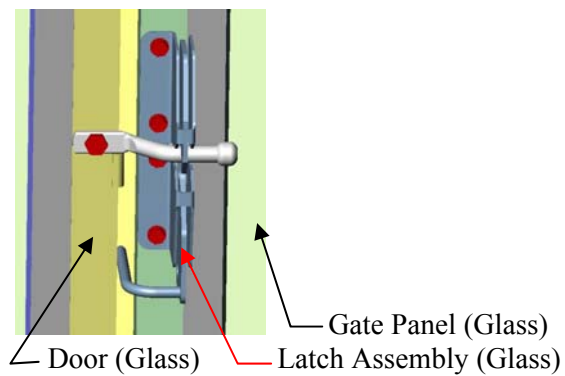

Figure 42A

Use the same installation instructions as shown above for the Glass Gate Panel Assembly.

M. Installation Options:

1. Top Wire Panel

Hardware Required



061.1010.00 - #12X1 TEK SCREW

Locate Top Wire Panel with slotted tabs. Position the Top Wire Panel with the tabs resting on the top of Side Panels equally spaced within the opening. Attach Top Wire Panel to the Side Panels using 1" Tek Screws through the slotted tabs as shown in **(Figure 43 & 44)**. The mount tabs are staggered to avoid interference with each other when assembling multiple kennels.

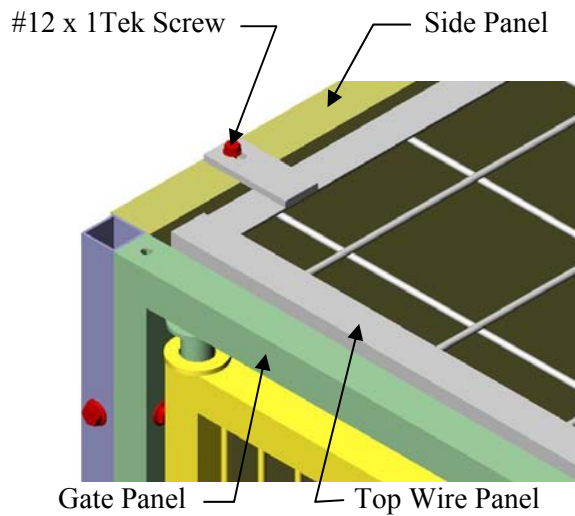

Figure 43

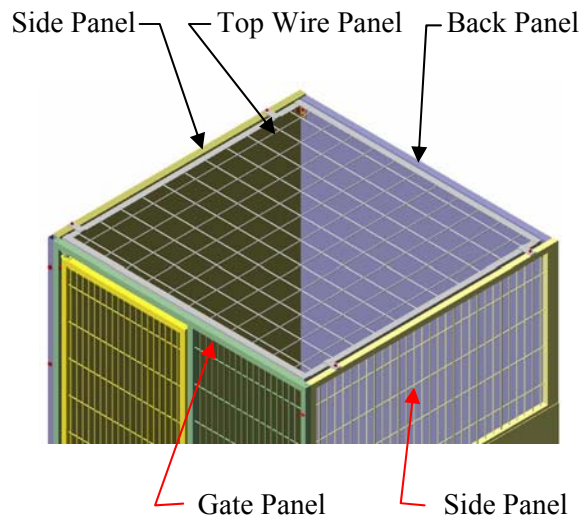







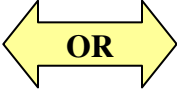



Figure 44

2. Side Transfer door Assembly

Hardware Required

 <p>061.1010.00 #12X1 TEK SCREW</p>	 <p>731.0000.08 BRACKET, TRANSFER DOOR</p>	 <p>310.0555.02 PULLEY NYLON</p>	 <p>062.2515.00 1/4X1.5 CAP SCREW</p>	 <p>064.2500.22 1/4 NYLOCK NUT</p>
 <p>043.0004.01 SLEEVE (FERRULE)</p>	 <p>041.0091.00 J-HOOK</p>	<p>J-HOOK</p>  <p>CARABINER</p>	 <p>193.0050.01 CARABINER</p>	

Install Pulley Bracket Assemblies using #12 x 1" long Self-Drilling Screws as shown. Locate J-Hook or Carabiner and Sleeve Compression.

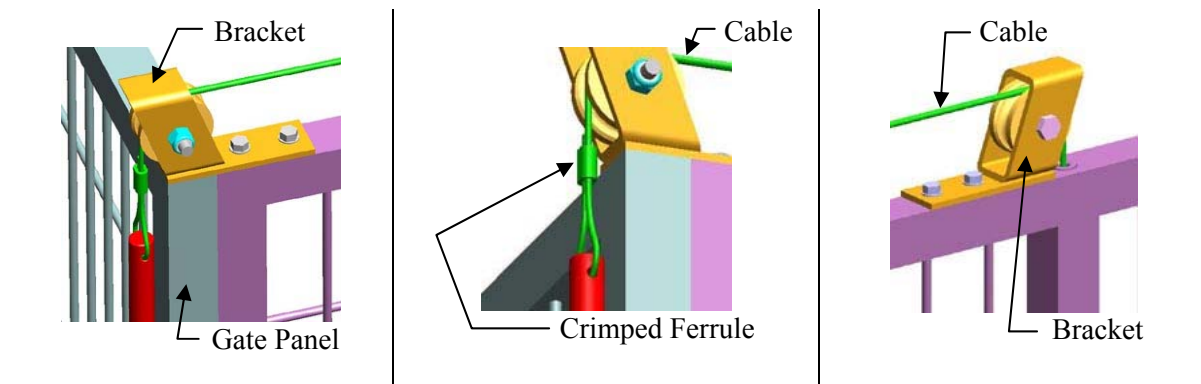
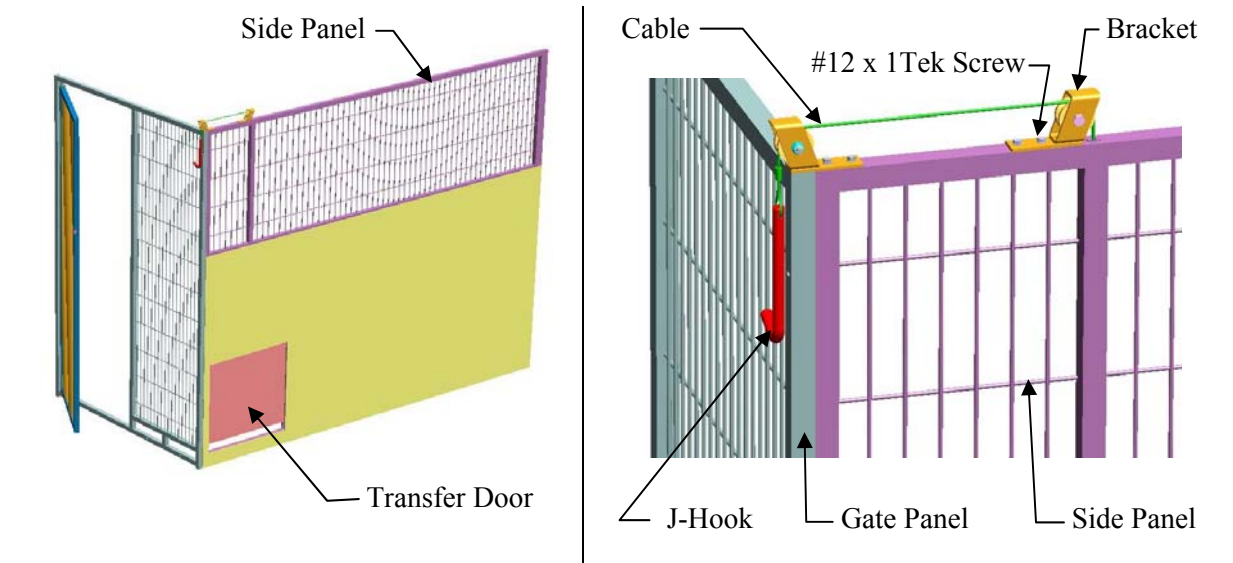

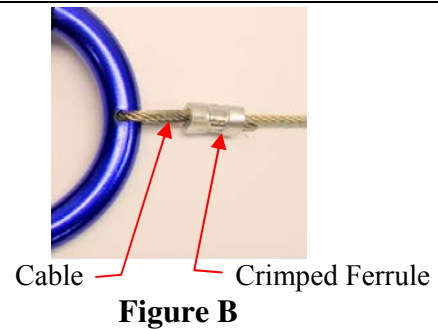
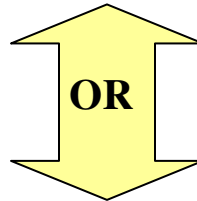
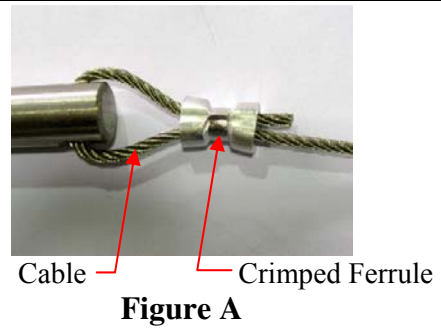
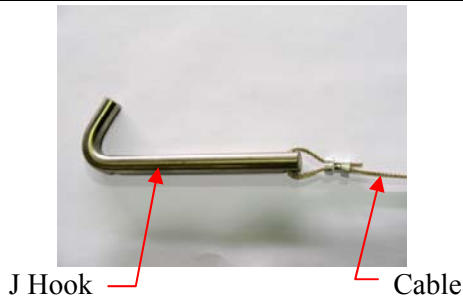
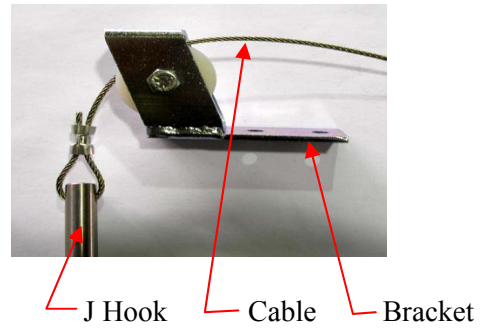
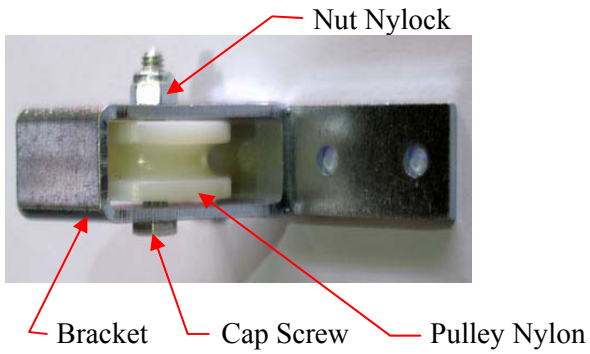

J-Hook or Carabiner Installation

To install the J-Hook or Carabiner for the optional transfer door, route the cable as shown in **(Figure A)**. Take an aluminum ferrule and route the cable through the ferrule, then through the hole in the J-Hook/Carabiner, and back through the ferrule.

Before crimping the ferrule to secure the cable, adjust the length of the cable so that the J-Hook or Carabiner can properly hook to the cross members of the wire mesh panel in a position that will hold the transfer door fully open. When you are satisfied with the position of the J-Hook/Carabiner, crimp the ferrule tightly to the cable and trim off any excess cable. **(Figure B)**

3. Feed Tray Cam Lock Installation

Hardware Required



058.3002.01 CAM LOCK



064.2500.17 BARREL NUT



085.1012.00 SPRING



062.2515.04 SCREW 1/4 W/TORQUE PATCH

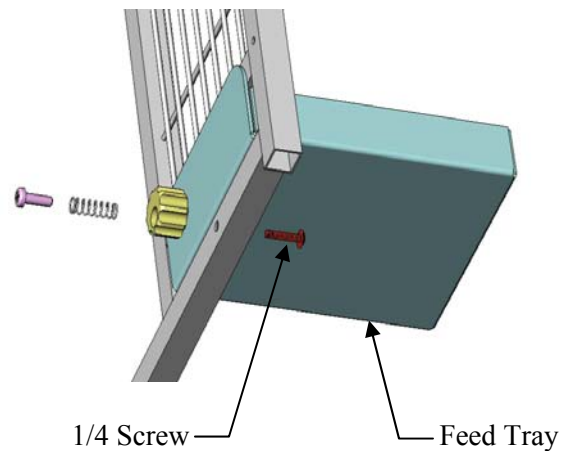
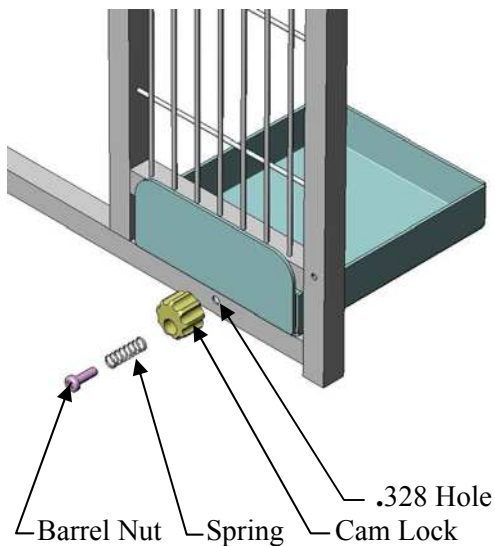

1. Locate .328 Diameter hole on the right hand side of bottom tube. Align Cam Lock 058.3002.01 with .328 diameter hole in bottom tube by holding larger diameter towards front.
2. Slide Spring 058.1012.00 onto a Barrel Nut 064.2500.17 and insert it into Cam Lock. Screw 062.2515.04 as shown from the backside of bottom tube and tighten securely.
3. Adjust the Cam Lock so that it can freely move clockwise or counterclockwise.
4. Insert Feed Tray into the Feed Tray slot. Turn Cam Lock to lock the Feed Tray in place.