



415 Osage Avenue, Kansas City, KS 66105

Phone: 913-281-0722

Fax: 931-281-3315

www.t-kennel.com

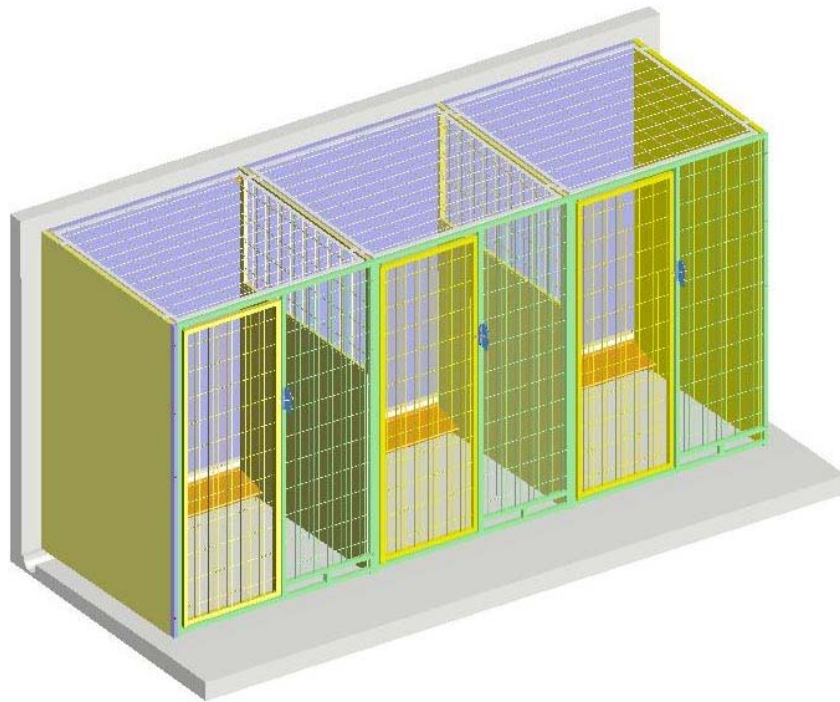

Single Kennel Installation on Concrete Floor

PN:006.5100.06

Updated: 8-1-2014

TABLE OF CONTENTS

SECTION	PAGE
INTRODUCTION	3
A. Tools Required	4
B. Kennel Assembly Hardware	5
C. King Post and Side Panel Assembly	6
D. Attach Gate Panel to King Post	7
E. Attach Brackets to the Back Panel	8
F. Attach Second Side Panel to Gate Panel	9
G. Attach Back Panel to the Side Panels	9
H. Sealing Kennel Assembly	10-11
I. Install T Cover Bracket	11
J. Install Half T Cover	12
K. Install Striker Bar and Latch Assembly	13
L. Installation Options	14
1. Top Wire Panel	14
2. Side Transfer Door Assembly	15-16
3. Using Customer Back and Side Wall	17
a. Attach Gate Panel to the Side Wall	17
b. Attach Side Panel to the Back Wall	17
c. Install T Cover Bracket	18
d. Install Half T Cover	18
4. Feed Tray Cam Lock Installation	19

INTRODUCTION

Thank you for placing your trust in T Kennel Systems. T Kennel values you as a customer and will do everything we can to provide quality products and service, to assure your experience with T Kennel is a pleasant one.

The animal kennel system you have purchased has been precision made and shipped according to your instructions. Once assembled, your system will look custom built and especially made for your animal holding area.

For your personal safety, the safety of your workers, the public safety, and to maintain your kennel system it is very important to read and follow all instructions.

KENNEL INSTALLATION MANUALS ARE AVAILABLE FOR:

Single Kennel Installation on Raised Floor

Double Kennel Installation on Raised Floor

Single Kennel Installation on Concrete Floor

Double Kennel Installation on Concrete Floor

SAFETY FIRST:

▲ | CAUTION Kennels are heavy and precautions must be taken to protect from personal injury. Get help when lifting heavy parts.

▲ | CAUTION Edges of steel and stainless steel kennels and parts may be sharp. We recommend that you always wear protective gloves during unloading, inspection and assembly.

▲ | WARNING T Kennel products are designed for animal use only. Never allow a person in or on your Kennel Assembly.



A. Tools Required (Not Included)

This list of tools is the minimum required to install/assemble your Kennels. Depending on your facility and kennel configuration, you may need additional tools and/or specialty tools.

 <p>RATCHET/SOCKET WRENCH WRENCH 5/16" AND 7/16"</p>	 <p>CAULKING GUN</p>
 <p>7/16 COMBINATION WRENCH</p>	 <p>SAUSAGE GUN Only required if Sealant Sausages are provided</p>
 <p>5/16" HEX HEAD DRIVER</p>	 <p>WIRE CRIMPING TOOL 3/32" FERRULE Only required for Transfer Door application</p>
 <p>SCREW GUN</p>	 <p>WIRE CUTTER Only required for Transfer Door application</p>

Other Tools: Tape Measure, Straight-Line (Laser or String), Pry-Bar, Screw Driver, Hammer, Chalk Line, Saw Zall with Bi-Metal Blade, Hammer Drill with concrete Bit, Tin Snip and Hacksaw.

B. Kennel Assembly Hardware

The hardware pictured below is for the assembly of T-Kennel's standard Single Kennel System. Your hardware may vary depending upon your kennel configuration, building design, etc. Please feel free to call our Sales Department or Tech Services Department if you have any questions.

 <p>041.0069.02 STRIKER BAR</p>	 <p>731.0000.00 LATCH ASSEMBLY-LH</p>	 <p>041.0087.00 BRACKET-LH</p>	 <p>041.0087.01 BRACKET-RH</p>
 <p>061.1010.00 #12X1 TEK SCREW</p>	 <p>061.1020.01 #12X2 TEK SCREW</p>	 <p>062.2515.00 1/4-20X1.5 CAP SCREW</p>	 <p>064.2500.22 1/4-20 NYLOCK NUT</p>
 <p>060.5000.00 SCREW 1/2 FL WASHER</p>	 <p>178.0008.00 ADHESIVE E6000, TUBE <i>CAULKING GUN REQUIRED</i></p>	 <p>SIKAFLEX SEALANT TUBE <i>CAULKING GUN REQUIRED</i></p>	 <p>SIKAFLEX SEALANT SAUSAGE <i>SAUSAGE GUN REQUIRED</i></p>
 <p>016.0001.00 SIKAFLEX PRIMER</p>	 <p>731.0000.01 LATCH ASSEMBLY-LH FOR GLASS GATE PANEL</p>	 <p>041.0142.01 ANGLE BRACKET 1-1/2"X2-1/2", SLOTTED Optional for the wall mounting</p>	
 <p>KING POST</p>			

C. King Post and Side Panel Assembly

(Note: The Kennel System is designed to assemble from left to right.)



King Post

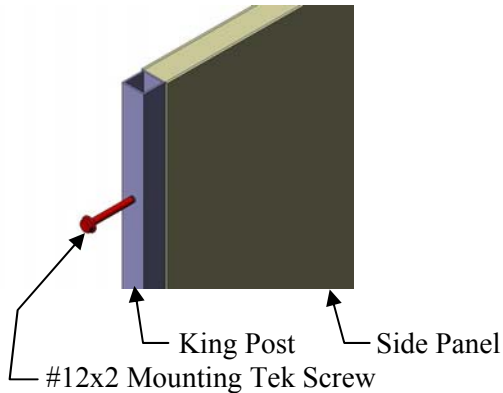

Figure 1

1. Attach a King Post to the first Side Panel on the far left using 2" Self-Drilling Tek Screws through the pre-drilled holes (**Figure 1**). The King Post should always mount to the short front end of the Side Panel.

Remove Door from each Gate Panel

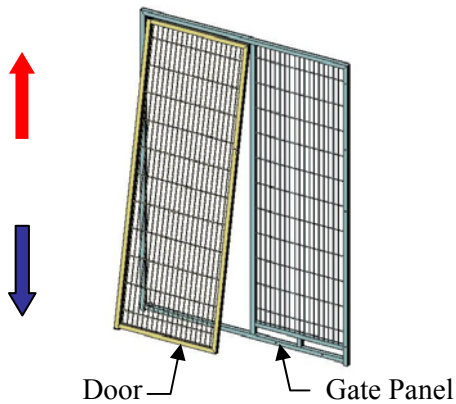

Figure 2

2. Locate the Gate Panels and remove the Door from each Gate Panel. Slightly open and lift up on the door. Once the Door clears the hinge pin at the bottom, pull the bottom of Door toward you (**Figure 2**). Pull the top of the Door down until the top of the Door clears the top hinge pin.

Mark all of the Doors so that they match with the original Gate Panels. Put the Doors aside until all the Gate Panels are ready to attach.

D. Attach Gate Panel to the King Post

1. Set the first Side Panel (with King Post attached) on the left side of the concrete floor. Be sure the bottom of the panel slopes from the front to back of the Kennel. Have a helper hold it in place (**Figure 3**).
2. Attach the Gate Panel to the King Post using 2" Self-Drilling Tek Screws through the pre-drilled holes. Make sure that Gate Panel and King Post are flush up against each other (**Figure 4**).

Note:

For kennels with the optional Stainless Steel Gates, you must pre-drill a pilot hole for the 2" self-drilling Tek Screws. Using the pre-drilled holes as a guide, drill 3/16" hole into the King Post or Gate Panel you are installing. We strongly suggest using a Cobalt drill-bit for this step.

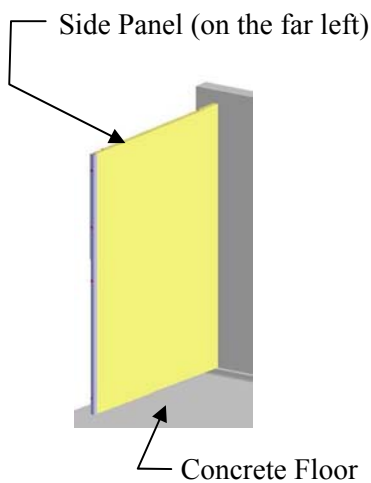

Figure 3

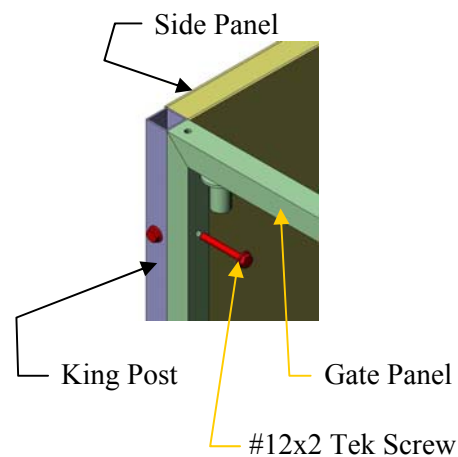

Figure 4

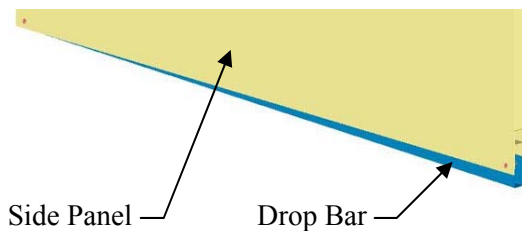

Figure 5

Note: On standard Side Panels, the slope is 1/4" per foot. Refer to your layout to confirm floor slope.

To match the bottom of the Side Panel with the slope of the concrete floor, adjust the Drop Bar, (located inside the u-channel at the bottom of the side panel), by pulling it downwards. (**Figure 5**). Make sure the Side Panel is level at the Top.

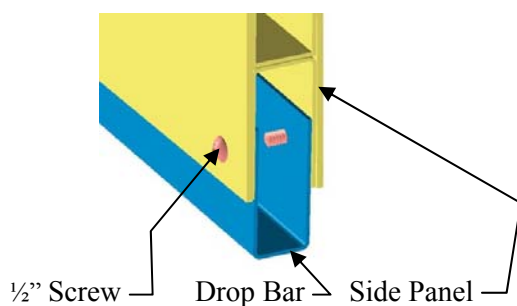

Figure 6

After making the final adjustment of the Drop Bar, secure it in place with 1/2" self-drilling screws on both sides of Side Panel at both ends as shown in (**Figure 6**).

Field Note: If the floor is not uniform, the Drop Bar can be cut and adjusted to adapt to most common floor irregularities.

E. Attach Brackets to the Back Panel

Note: If your layout is using your existing back and or end walls refer to pg17 for attachment instructions.

Figure 7 shows the front side of the Back Panel with PVC that should face the inside of the Kennel. **Figure 8** shows the correct structural orientation with a view from the backside of the Back Panel.

1. Locate the Brackets (as shown) used to attach the Back Panel. The Bracket should have three drilled holes. Use 1" Tek Screws to attach the Brackets to the Back Panel first by using the side of the Bracket where two holes are drilled. The upper Brackets should be flush with top and the lower Brackets should be flush with the bottom of the Back Panel (**Figure 7**).

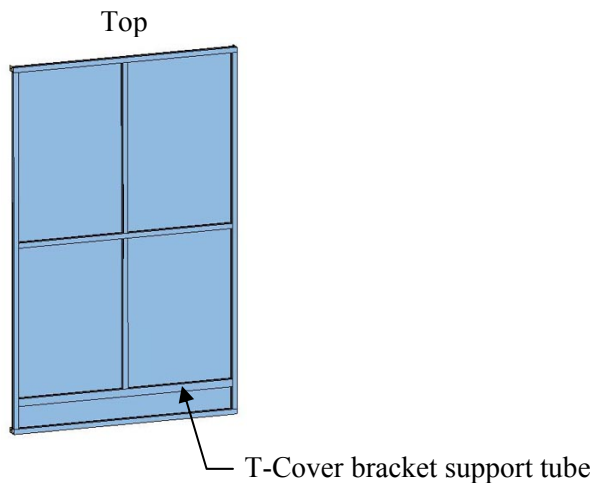
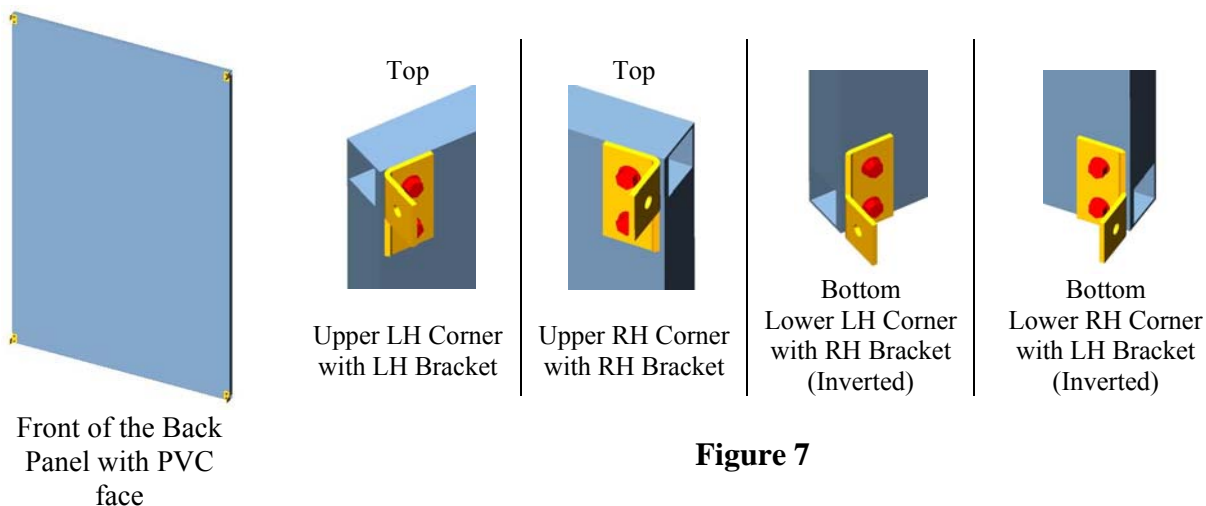

2. After installing the Brackets, place the Back Panel inside at the back of the kennel, PVC facing towards the Gate Panel. This will eliminate the need to lift it over the top of the kennel when it is time to install. Make sure to install the Back Panel with the T Cover bracket support tube facing down as shown in (**Figure 8**), (Do not attach to anything at this time).

F. Attach Second Side Panel to the Gate Panel

Mount the second Side Panel to the Gate Panel using 2" Self-Drilling Tek Screws through the pre-drilled holes (**Figure 9 & 9A**).

Note: From Second Kennel on, the Gate Panels will attach to the preceding Kennels' Gate Panel.

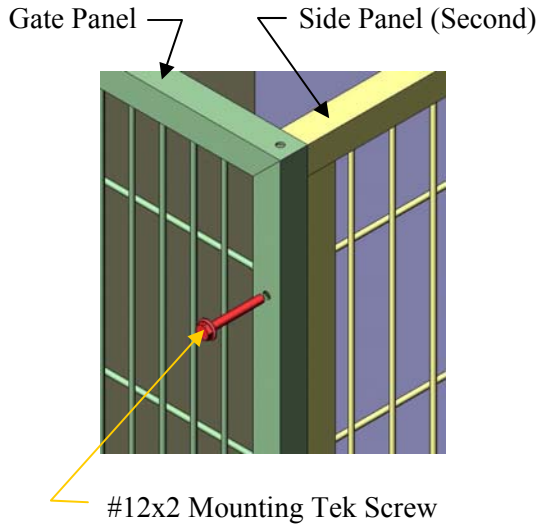

Figure 9

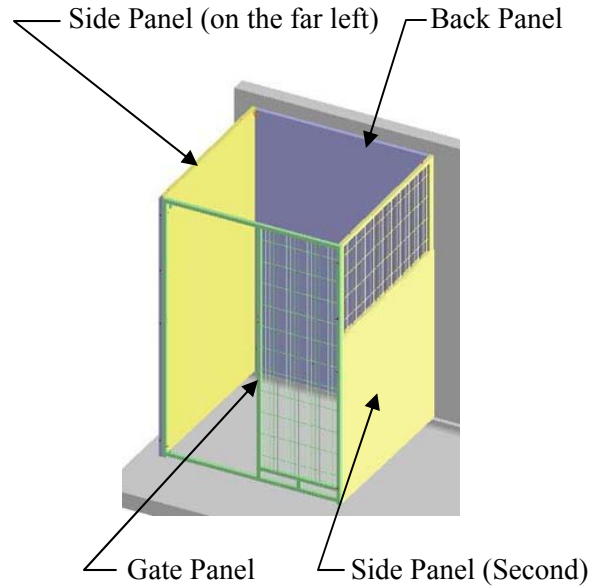
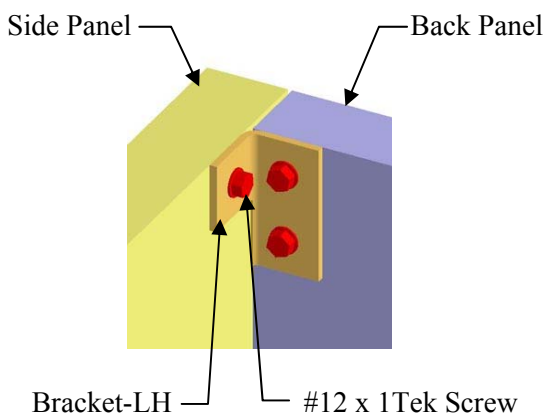

Figure 9A

G. Attach Back Panel to the Side Panels

Attach the Back Panel to the first Side Panel (**Figure 10 & 11**) using 1" Tek Screws. Attach Back Panel to the second Side Panel. Continue assembling the Kennels by repeating the steps in F, G and H



Upper Left Hand Corner
Figure 10

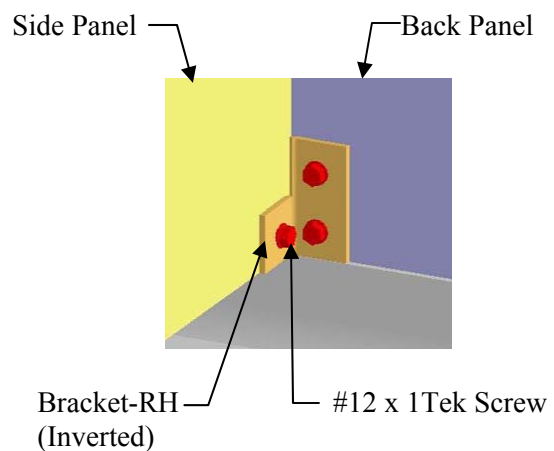

Lower left Hand Corner
Figure 11

H. Sealing Kennel Assembly

READ THIS ENTIRE SECTION PRIOR TO SEALING THE KENNELS. The goal is to start in the back of the kennel and work your way out. Having to walk into a freshly sealed kennel may compromise the sealant and possibly cause leaking.

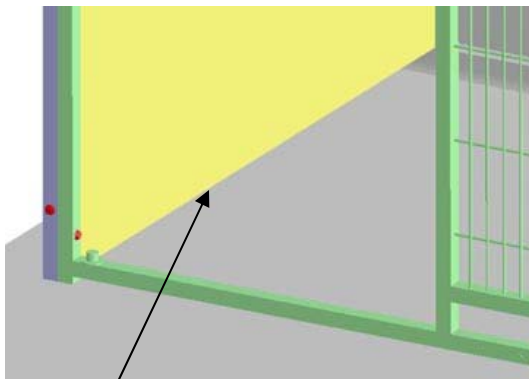

Clean all the corners and seams

Figure 12

1. Use a primer or Isopropyl Alcohol (read health hazard information) to clean all the corners, cracks, edges, and areas that need to be sealed. This should remove any dust or oil that would inhibit good adhesion (**Figure 12**).

2. Cut the Sealant tube (**J. Kennel Assembly Hardware**) end off at a 60° angle (**Figure 13**). The hole should be about the diameter of a ballpoint pen. Use a coat hanger or longer pin to poke a hole in the Sealant tube to start the flow (**Figure 14**).



Figure 13



Figure 14



Figure 15

Sealing Tip: Running a strip of masking tape (**Figure 15**) approximately ¼” from either side of the seam to be sealed will help produce a professional looking caulking job.

3. Begin sealing at the back of the kennel. Seal the corners where the Side Panels meet the Back Panel, working top to bottom. Smooth the sealant with the tip of your gloved finger so that there are no gaps or pinholes in the sealant. It may help to dip your gloved finger into a bowl of dish detergent to prevent sticking. After applying and smoothing the sealant with you finger, peel off the masking tape using caution not to smear the fresh sealant.



4. Seal the Side Panels to the floor working back to front. Smooth the sealant with the tip of your gloved finger so that there are no gaps or pinholes in the sealant. Refer to the sealant manufacturer's directions for drying times. We strongly suggest waiting at least 72 hours for the sealant to cure completely before applying any water or using the kennels.

I. Install T Cover Bracket

To locate the T Cover Bracket, measure 7" from the bottom of the Back Panel to the top of the Bracket. Attach the Bracket to the Back Panel using 1" Tek Screws (**Figure 16 & 17**). Make sure the 1" Tek Screws hit the tube cross member of the Back Panel (**Figure 8**). The Bracket should be equally spaced from the both ends of the Back Panel.

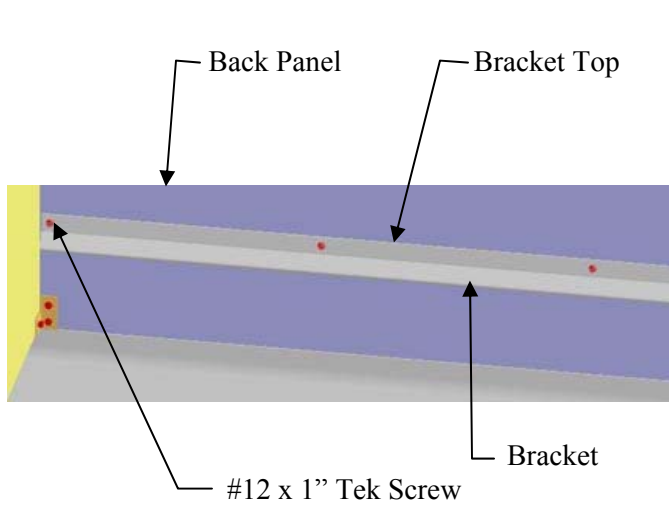

Figure 16

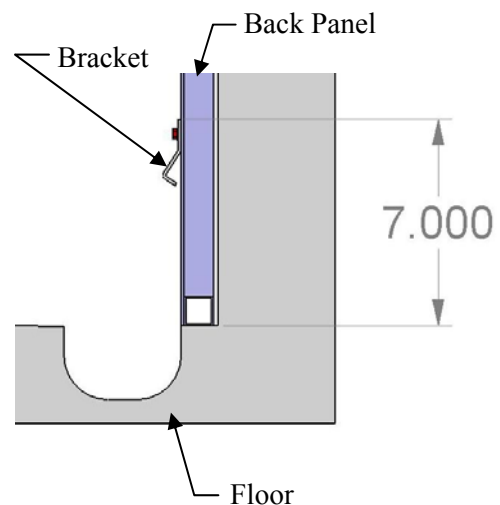
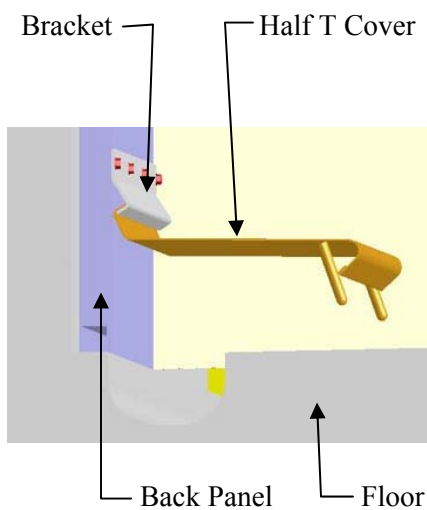

Figure 17

J. Install Half T Cover

Hang the Half T Cover from the Bracket by tilting the Half T Cover back and up into the Bracket as shown in (**Figure 18 & 19**). The legs of the Half T Cover will touch the Floor and it will fully cover the trench drain.



T Cover in tilting position
Figure 18

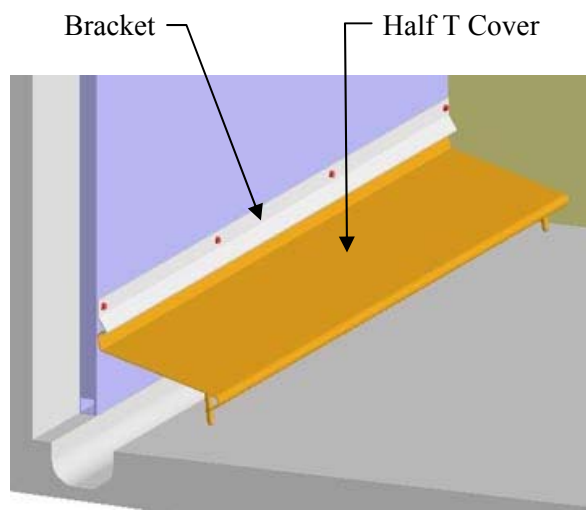

Half T Cover Installed
Figure 19

K. Install Striker Bar and Latch Assembly

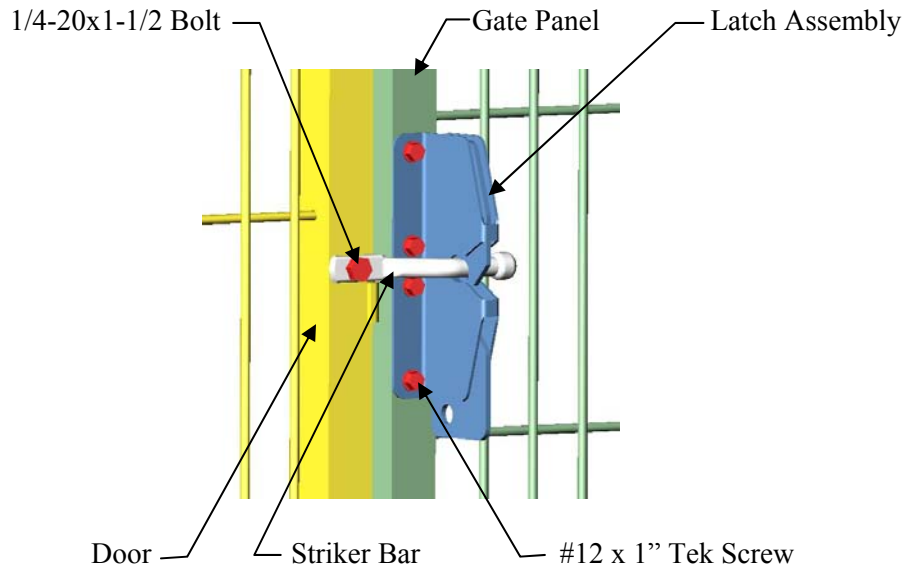

Figure 20

1. Install the Striker Bar to the pre-drilled Door using a 1/4"-20 x 1-1/2 Hex Bolt and 1/4"-20 Nylox Nut (**Figure 20**). Position the Striker bar into a horizontal position.

Note:

To install the Latch Assembly to an **Optional** Stainless Steel Gate Panel, you must pre-drill the holes using a 3/16 cobalt drill bit through only one wall of tube for the 1" Tek Screws by matching with the pre-drilled holes in the Latch Assembly.

2. Hold the Latch Assembly in place against the Gate Panel and close the Door. Make sure to center the Striker Bar within the latch pocket and latch looks straight. Using (4) 1" Tek Screws, attach the Latch Assembly to the Gate Panel (**Figure 20 & 20A**).

Latch Assembly for optional Glass Gate Panel Assembly

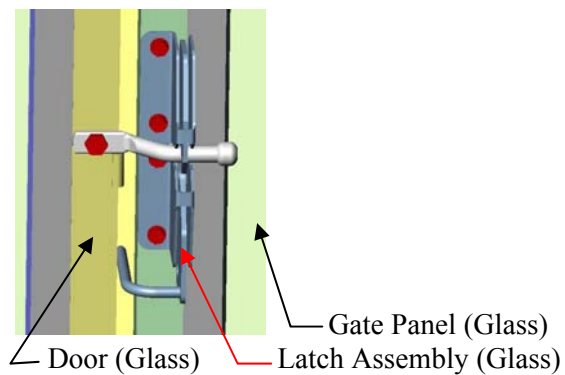

Figure 20A

Use the same installation instructions as shown above for the Glass Gate Panel Assembly.

L. Installation Options:

1. Top Wire Panel

Hardware Required



061.1010.00 - #12X1 TEK SCREW

Locate Top Wire Panel with slotted tabs. Position the Top Wire Panel with the tabs resting on the top of Side Panels equally spaced within the opening. Attach Top Wire Panel to the Side Panels using 1" Tek Screws through the slotted tabs as shown in **(Figure 21 & 22)**. The mount tabs are staggered to avoid interference with each other when assembling multiple kennels.

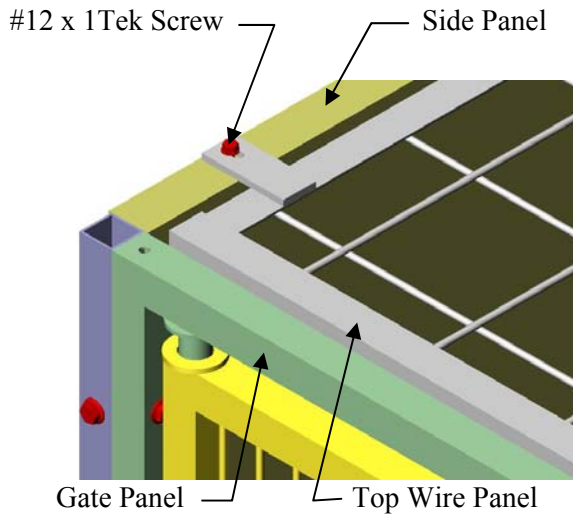

Figure 21

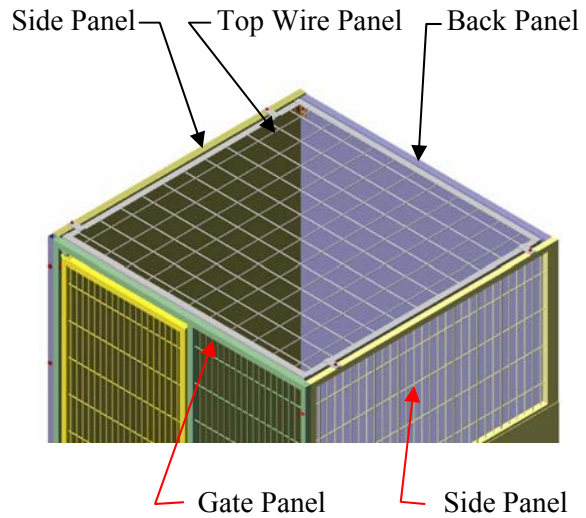









Figure 22

2. Side Transfer door Assembly

Hardware Required

 <p>061.1010.00 #12X1 TEK SCREW</p>	 <p>731.0000.08 BRACKET, TRANSFER DOOR</p>	 <p>310.0555.02 PULLEY NYLON</p>	 <p>062.2515.00 1/4X1.5 CAP SCREW</p>	 <p>064.2500.22 1/4 NYLOCK NUT</p>
 <p>043.0004.01 SLEEVE (FERRULE)</p>	 <p>041.0091.00 J-HOOK</p>	<p>J-HOOK OR CARABINER</p>	 <p>193.0050.01 CARABINER</p>	

Install Pulley Bracket Assemblies using #12 x 1" long Self-Drilling Screws as shown. Locate J-Hook or Carabiner and Ferrule.

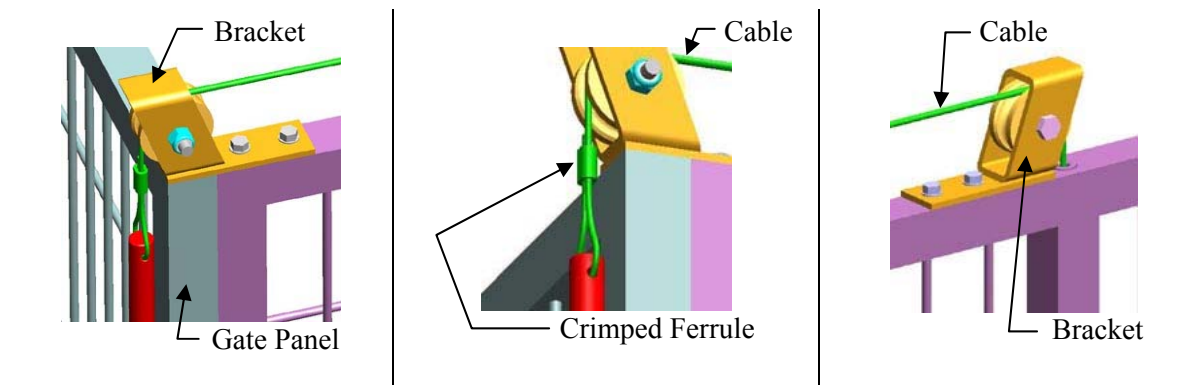
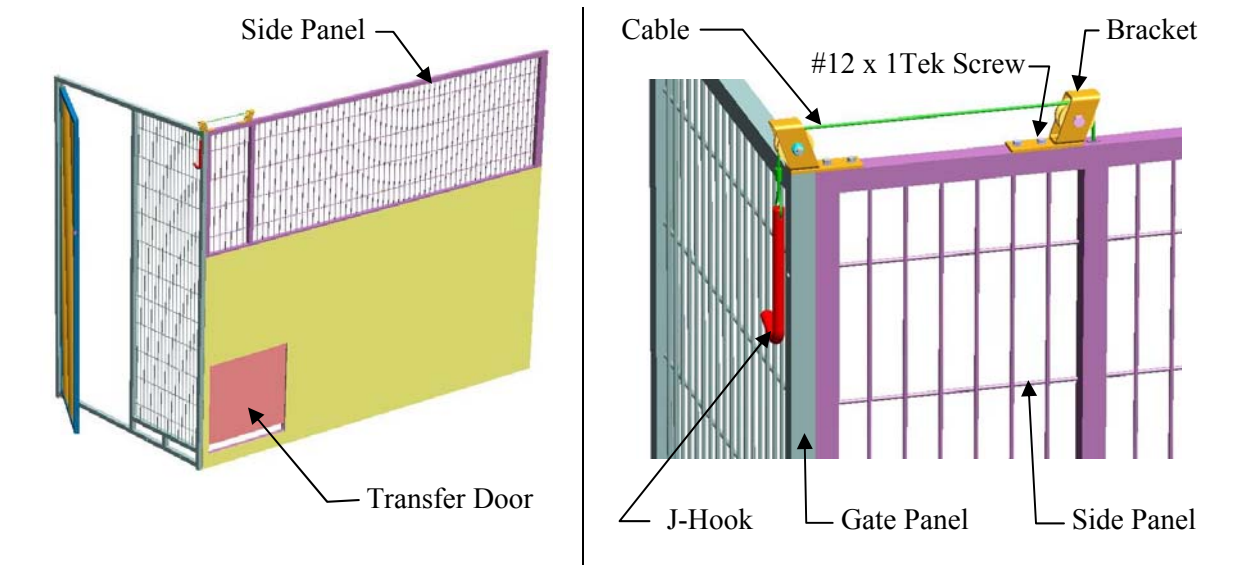

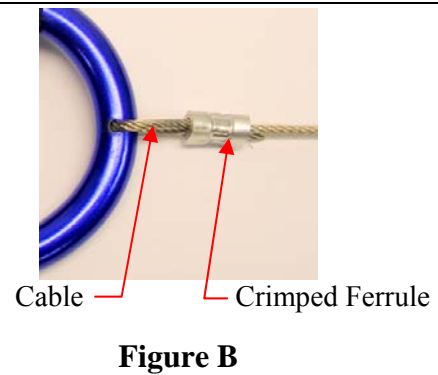
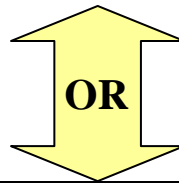
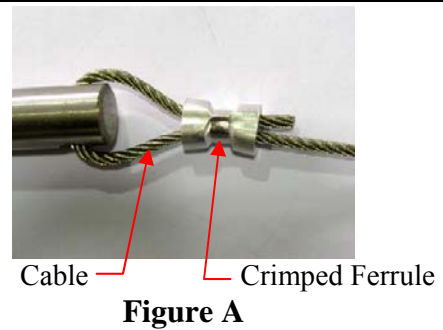
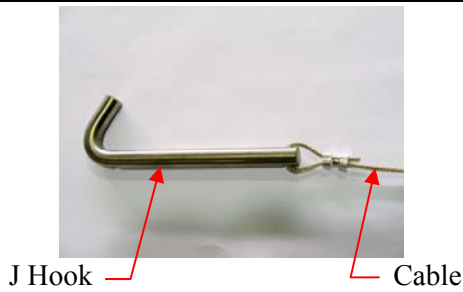
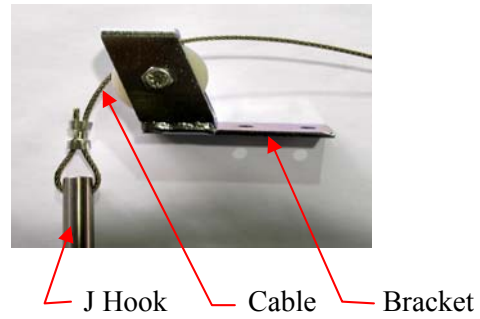
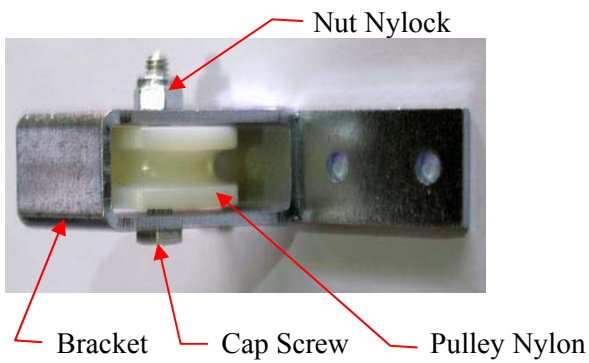

J-Hook or Carabiner Installation

To install the J-Hook or Carabiner for the optional transfer door, route the cable as shown in **(Figure A)**. Take an aluminum ferrule and route the cable through the ferrule, then through the hole in the J-Hook/Carabiner, and back through the ferrule.

Before crimping the ferrule to secure the cable, adjust the length of the cable so that the J-Hook or Carabiner can properly hook to the cross members of the wire mesh panel in a position that will hold the transfer door fully open. When you are satisfied with the position of the J-Hook/Carabiner, crimp the ferrule tightly to the cable and trim off any excess cable **(Figure B)**.

3. Using Customer Back and Side Wall

a. Attach Gate Panel to the Side Wall

Hardware Required



O41.0142.01 ANGLE BRACKET
1-1/2"x2-1/2" SLOTTED



061.1010.00
#12X1 TEK SCREW

AND CUSTOMER'S
HARDWARE

Locate 1-1/2" x 2-1/2" slotted Angle Bracket. Attach Bracket with short flange to the side wall, using customer's hardware. Attach the Bracket with longer flange to the Gate Panel using 1" Tek Screw. The upper edge of Bracket should be flush with top of the Gate Panel.

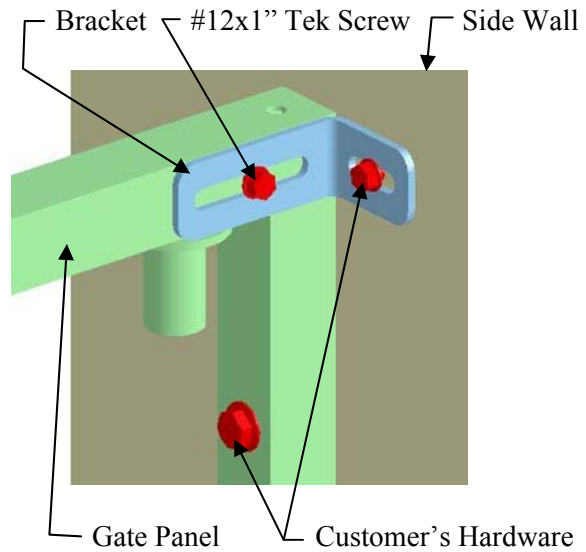

Looking from the inside of the kennel

b. Attach Side Panel to the Back Wall

Locate 1-1/2" x 2-1/2" slotted Angle Bracket. Attach Bracket with short flange to the back wall, using customer's hardware. Attach the Bracket with longer flange to the side Panel using 1" Tek Screw. The upper edge of Bracket should be flush with top of the Side Panel and the lower Brackets should be flush with the bottom of the Side Panel.

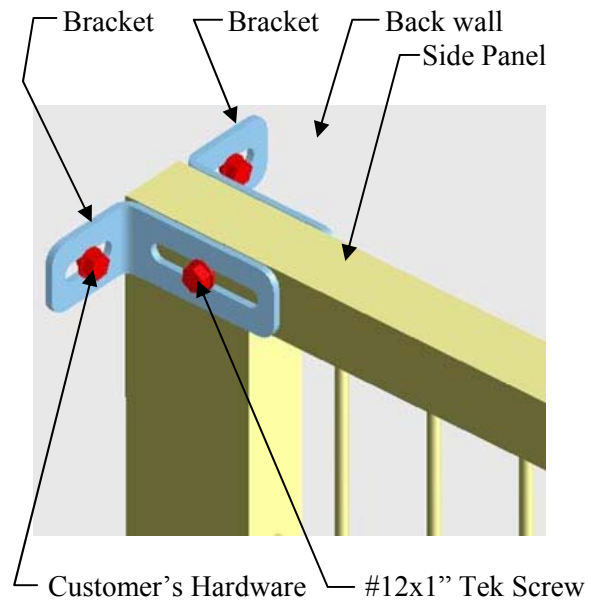

C. Install T Cover Bracket

To locate the T Cover Bracket, measure 7" from the bottom of the floor to the top of the Bracket. Attach the Bracket to the wall, using customer's hardware. Make sure the customer's Screws hit the solid surface in case of dry wall. The Bracket should be equally spaced within the kennel.

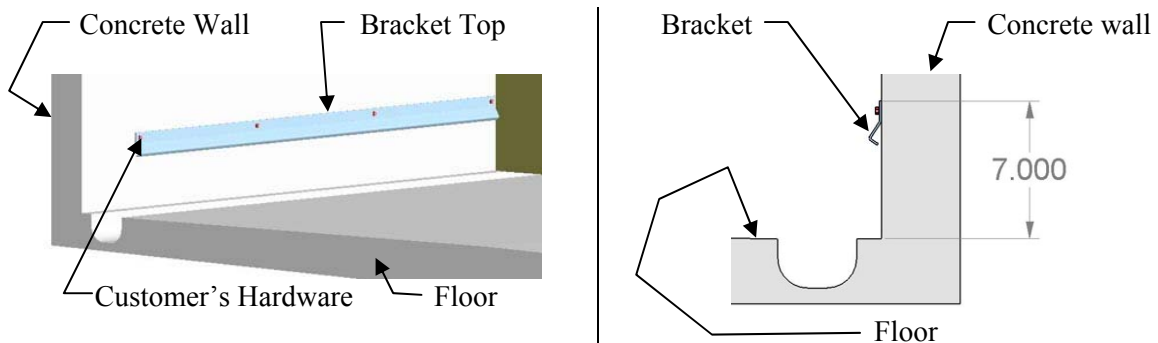

d. Install Half T Cover

Hang the Half T Cover from the Bracket by tilting the Half T Cover back and up into the Bracket as shown. The legs of the Half T Cover will touch the Floor and it will fully cover the trench drain.

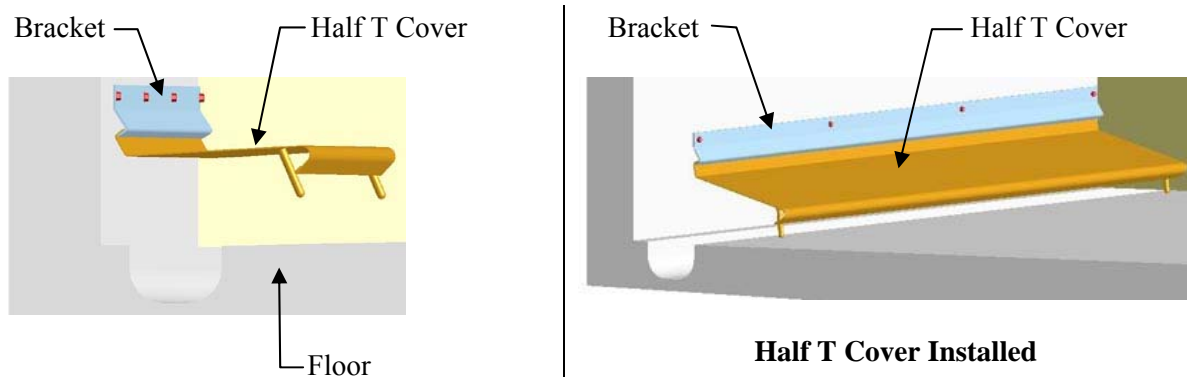

4. Feed Tray Cam Lock Installation

Hardware Required



058.3002.01 CAM LOCK



064.2500.17 BARREL NUT



085.1012.00 SPRING



062.2515.04 SCREW 1/4 W/TORQUE PATCH

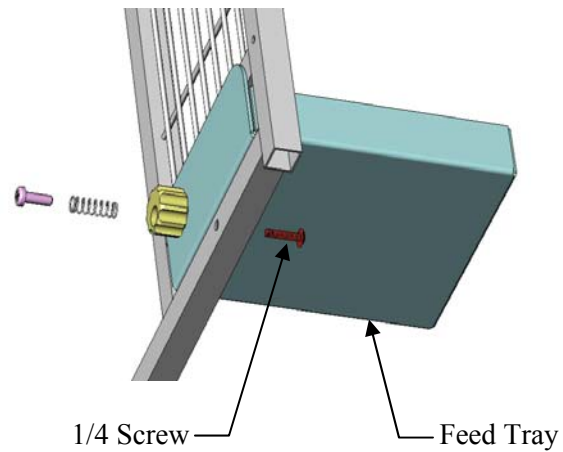
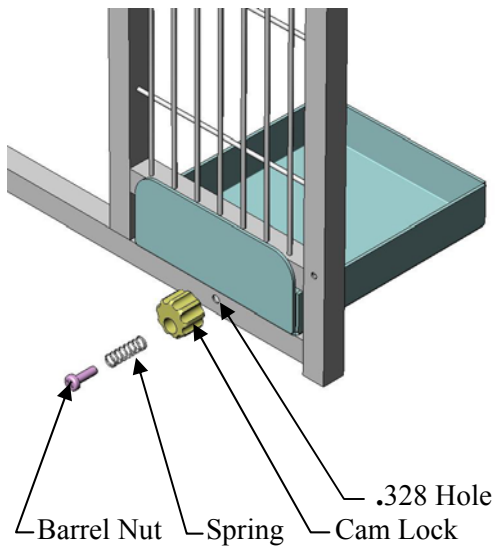

1. Locate .328 Diameter hole on the right hand side of bottom tube. Align Cam Lock 058.3002.01 with .328 diameter hole in bottom tube by holding larger diameter towards front.
2. Slide Spring 058.1012.00 onto a Barrel Nut 064.2500.17 and insert it into Cam Lock. Screw 062.2515.04 as shown from the backside of bottom tube and tighten securely.
3. Adjust the Cam Lock so that it can freely move clockwise or counterclockwise.
4. Insert Feed Tray into the Feed Tray slot. Turn Cam Lock to lock the Feed Tray in place.